

**User Manual**  
**For**  
**Mobile Digital Video Recorder**  
**(hereinafter referred to as MDVR)**  
**Hero-ME31-08**

**Howen Technologies,LTD**  
**2018-2019**

## Content

1. Overview .....	3
2. Cautions .....	3
2.1. Installation Environment .....	3
2.2. Avoid electric shock and fire .....	3
2.3. Transport and operation .....	3
3. Product introduction .....	3
4. Product Specification .....	4
5. Mainframe .....	4
5.1. Interface .....	4
5.2. Front panel .....	5
5.3. Rear panel .....	5
5.4. Pin definition of Audio/Video input/output port .....	6
5.5. Pin definition of IO&Serial port for other models .....	6
5.6. Remote controller .....	7
6. Device and installation .....	8
6.Connect power with MDVR.....	10
7. System diagram .....	12
8. Menu structure .....	12
9. System operations .....	13
9.1. User login.....	13
9.2. Main menu .....	14
9.2.1. Search .....	14
9.2.1.1. Video Searching.....	15
9.2.1.2. Log search .....	16
9.2.1.3. Picture search .....	17
9.2.2. System setting .....	17
9.2.2.1. Register info .....	18
9.2.2.2. User .....	18
9.2.2.3. Time setup.....	19
9.2.2.4. Startup .....	20
9.2.2.5. Config .....	20
9.2.2.6. Format .....	21
9.2.3. Record .....	21
9.2.3.1. General .....	22
9.2.3.2. Main stream .....	23
9.2.3.3. Sub stream .....	24
9.2.3.4. Timed recording .....	25
9.2.3.5. Storage setting .....	26
9.2.3.6. OSD Set .....	27
9.2.4. Network Setting(Not available for ME40-04) .....	27
9.2.4.1. Center settings .....	27
9.2.4.2. Local Network Setup .....	29
9.2.4.3. Dial settings.....	29
9.2.4.4. WiFi settings.....	30
9.2.5. Alarm .....	31
9.2.5.1. IO Alarm .....	31
9.2.5.2. Speed Alarm .....	32
9.2.5.3. Acceleration.....	33
9.2.5.4. Motion Detection .....	34
9.2.5.5. Voltage alarm .....	35
9.2.5.6. Serial .....	36
9.2.5.7. PTZ Control.....	36
9.2.5.8. Fatigue Driving .....	37
9.2.6. System Info.....	37

## 1. Overview

This manual is the instruction manual for Hero-ME31-08 series MDVR as below:

Please read the manual before you using the product.

The manual will be updated from time to time without prior notice.

## 2. Cautions

### 2.1. Installation Environment

1. To extend equipment life, please install the equipment in locations with little vibration.
2. To ensure normal heat dissipation, do not install the device in a poorly-ventilated area (such as trunk), and also keep about 15 cm away from other objects on the same level.
3. The device shall be horizontally installed and protected against water, humidity and lightning; in addition, keep the vehicle still during installation to prevent damage to the device due to falling off.
4. To ensure safe operation, keep the device, camera, cables and other accessories out of reach of passengers and driver.

### 2.2. Avoid electric shock and fire

1. The machine uses 8V-36V DC power supply, notice the polarity when wiring to avoid short circuits.
2. Please power off the device when connecting accessories with device.
3. Do not touch the power and the device with wet hands.
4. Do not spray liquid on the device to prevent internal short circuit or fire.
5. Do not put any other equipment on top of camera.
6. Do not disassemble the housing without authorization to avoid damage or electric shock.

### 2.3. Transport and operation

1. Please use the original package in transport to avoid damage in transport.
2. Please keep power off in moving the device or replacing components.

## 3. Product introduction

The 4CH&8CH MDVR supports 4/8 channels analog audio and video recording and playback with network function.

The product adopts ARM DSP fast dual-core processor running on the Linux embedded OS, and also integrates the most advanced H.264/H.265 video encoding/decoding in IT industry, 3G/4G network, GPS and Wi-Fi, as well as power-failure protection, HDD shock absorption, HDD heating, wide voltage features.

It is extensively applied in public buses, logistics vehicles, school buses, police cars, financial convoy cars and fuel tankers.

### Main Features:

- Supports 4/8 ch AHD 720P/ 1080P cameras
- Industry leading CPU with powerful processing ability
- Supports HDD/SSD/SD CARD for recording. Max. 2TB HDD.
- "Plug and Recording" Hard disk: innovative hard disk mounting design, no need to mount screws
- Robust design: Cast aluminum enclosure. Patented design
- Selected industrial power chip-sets, support 8-36V wide range power input, adapt to harsh environment
- Support UPS
- Support low/high temperature environment
- Support external Fireproof box, to backup data in extreme scenarios
- Support backup recording
- Dual streams for local recording and network transmission
- Support 3G/4G, Wi-Fi, GPS modules.
- Built-in G-sensor for harsh acceleration/deceleration detection

- Data self-protection, save data when shut down abnormally

#### 4. Product Specification





Power input	DC: +8V ~ +36V	8V~36V, Check the supply voltage of the vehicle battery before use; If it is supplied with more than 36V for a prolonged period, the device may be damaged.
Power output	+12V@2.5A, +5V@2A	
ACC detection	≤4V	Power off
	≥5V	Power on
Video input impedance	75Ω	Each video input impedance: 75Ω
Video output voltage	2Vp-p	2VP-P CVBS output analog signal which should be adapted by 75Ω of input impedance from the display unit.
I/O interface	<1V	Low level alarm
	>5V	High level alarm
Operating temperature	-20°C~70°C	In a well-ventilated place

### 5. Mainframe







#### 5.1. Interface



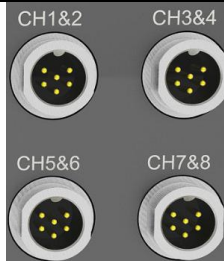

### 5.2. Front panel

Interface	Name	Description
	IR	Infrared Receiver
	HDD Slot	2.5 inch SATA HDD slot. Please unlock the lock with the key. You can also see SD card slot and SIM card slot with HDD slot together.
	Lock&Open	Open and lock the door for HDD/SD card/SIM card slot; On/off switch for device power;
	USB	For USB mouse,USB flash drive,etc.
	LED	LED Indicators. Green is on status. SD/HDD LED blinking means it's recording.Alarm blinking means there is an alarm.

### 5.3. Rear panel

Interface	Name	Description
	CH1/CH2/CH3/CH4/ CH5/CH6/CH7/CH8	Connect with cameras. The port can provide DC12V power to cameras directly.
	AV Out	4pin aviation connector; Connect with monitor; The port will output audio and video to screen.
	3G/4G LTE	Connect with 3G/4G LTE antenna.
	GPS	Connect with GPS antenna.
	WIFI	Connect with WIFI antenna.
	Power	Connect with power adapter/battery

 <p>LAN</p>	LAN	Connect with network cable for network
 <p>I/O&amp;Serial</p>	I/O&Serial	For IO cables; Including sensor input,sensor output,DC power output, RS232, RS485, sensor

#### 5.4. Pin definition of Audio/Video input/output port



#### 5.5. Pin definition of IO&Serial port for other models

The port contains below interfaces:

- DC12V OUT;
- DC5V OUT;
- RS232;
- RS485;
- Sensor Input;
- Sensor Output;
- Video Out;
- Audio Out;
- Speed pulse;
- MIC;



1	2	3	4	5	6	7	8	9	10	11	12	13	14	15
---	---	---	---	---	---	---	---	---	----	----	----	----	----	----

VCC12V-OUT	GND	RS232-RX1-Debug	RS232-TX1-Debug	Speed-A	SENSO R-IN-6	RS485-B3	RS232-RX2	SENSO R-IN-9	SNESOR-OUT-1	SENSO R-IN-3	GND	VIDEO-OUT	MIC-	RS232-TX1
16	17	18	19	20	21	22	23	24	25	26	27	28	29	30
VCC5V-OUT	GND	GND	Speed-B	SENSO R-IN-7	SENSO R-OUT-2	RS485-A3	RS232-TX2	SENSO R-IN-5	SNESOR-IN-4	SNESOR-IN-2	SENSO R-IN-1	AUDIO-OUT	MIC+	RS232-RX1

### 5.6. Remote controller



<b>Login</b>	When the recorder is set with a password, press the Login key to input your password. As the system is not provided with recover and reset features, always keep your password in mind.
<b>INFO</b> key	Short-cut for check the device's information.
<b>Enter</b> key	Confirm , enter into the input mode.



Number key 1, 2, 3, 4	You can press number 1/2/3/4 to display channel 1, channel 2, and channel 3 and channel respectively.
<b>Return</b> key	Return to the previous menu, and finally exit from the setup menu to the monitoring interface.
<b>DEL</b> key	Delete when input the numbers by remote.
<b>Play</b> key	Press this key to start playing (search the video file to be played and select, then press the key to play it).
<b>Forward</b> key	Forward key in four grades: 2X,4X,8X,16X
<b>Rewind</b> key	Rewind key in four grades: 2X,4X,8X,16X
<b>Next</b> key	Page down or roll to the next file.
<b>Previous</b> key	Page up or roll to the previous file.
<b>PTZ</b> key	PTZ, Focus+ ,Focus-
<b>F1</b>	F1 is a key to start functional test

## 6. Device and installation

1. Unlock the electric lock on front panel



**Hero-ME31-08**

2. Install disk
  - A. Take the pad from the package, get rid of the sticker label, then stick to the HDD.





B. Unscrew the screw in the front panel by hand, take the HDD case out.

C. Unscrew the screw of HDD case. Take the sticker label off, the install the rubber holder. Then install the Hard disk , please mind the direction.



3. Install SIM card and SD card.

Install SIM card and SD CARD.

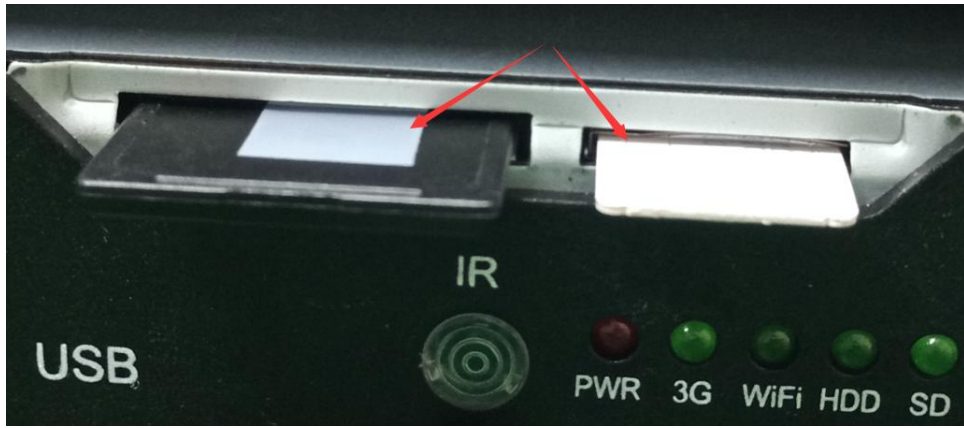

4. Put the HDD disk case back, fix it . Lock the electric lock.



5. Connect 3G/WIFI/GPS antennas  
Connect 3G/WIFI/GPS antennas according to labels on antennas and connectors.



6. Connect power with MDVR  
Use DC12V, 3A(at least) or **higher(5A is better)** power adapter in office test.

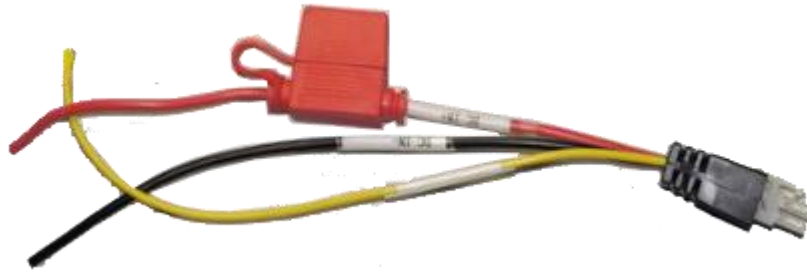

MDVR Power connection for test

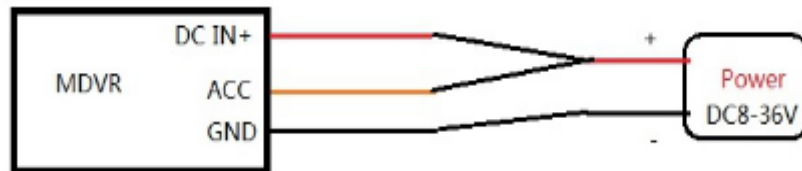

For the vehicle, must install like this.

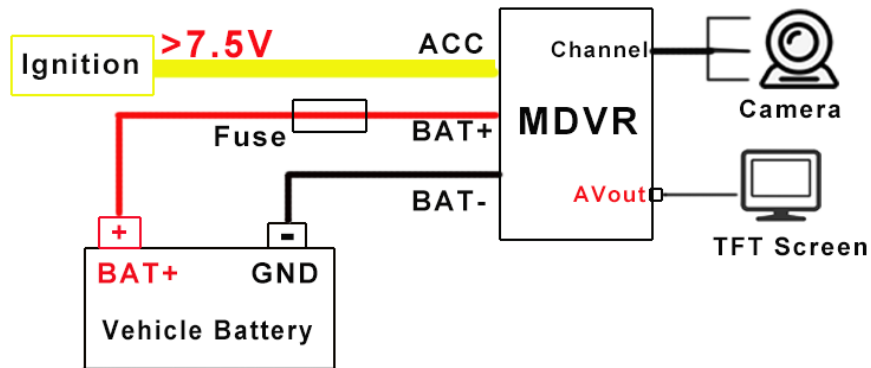

7. Connect TFT monitor

Connect a TFT monitor with AVOUT port on the rear panel of MDVR.

**Attention:** The MDVR will provide power and image to TFT screen by Avout port, so don't connect any external power for the TFT screen, or else, it will destroy the MDVR.

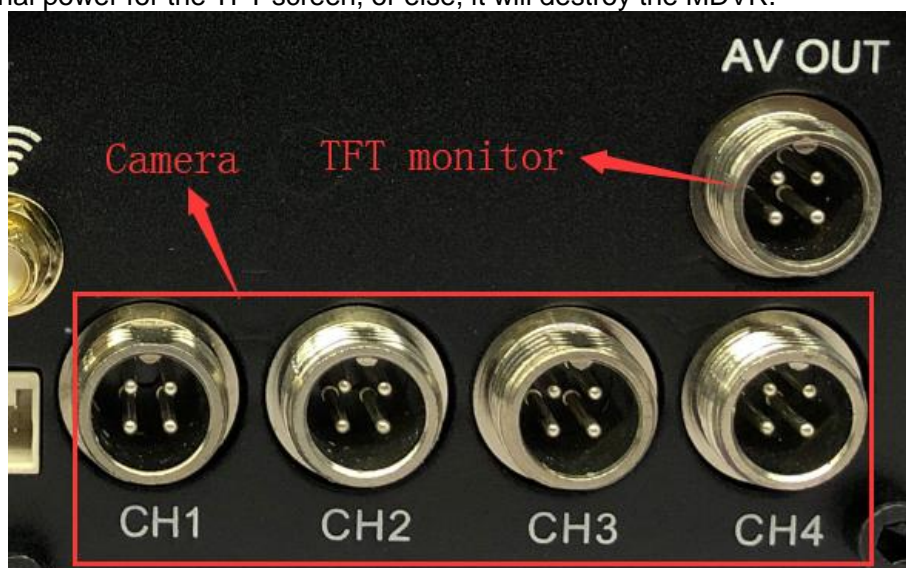

## 7. System diagram

This product is suitable for video monitoring or remote monitoring and applicable for general or special vehicles. It mainly uses the special designed vehicle camera to acquire the front video signal, then transmits the signal via a special video cable to the MDVR mainframe for video compression and image processing and finally stored in the HDD.

It can also locate where the vehicle is in real time via GPS module, and then upload the location information to the remote server via 3G/4G module. You can download video files from the remote client to realize real-time remote monitoring of the vehicle. The following shows the actual application model of this product that may be different depending on vehicle type and peripherals.

For Hero-ME40-04, the structure is simple. It is only for recording on the device, without the network (3G/4G, WIFI), so it will not transmit the data to server. You can play on the device directly or by MDVR player (get the map information and video).

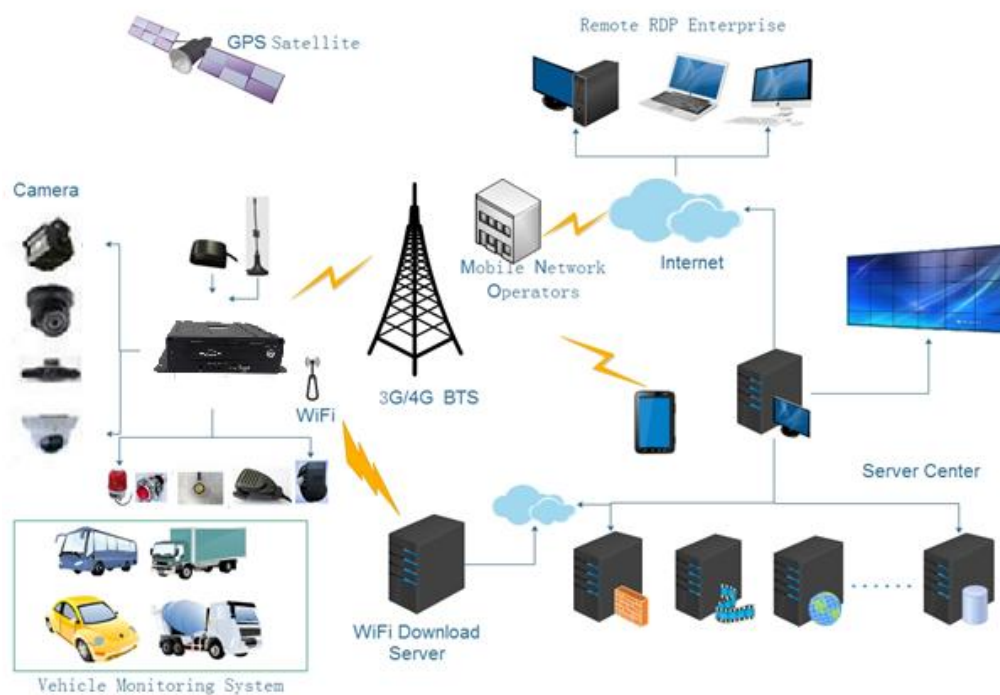

## 8. Menu structure



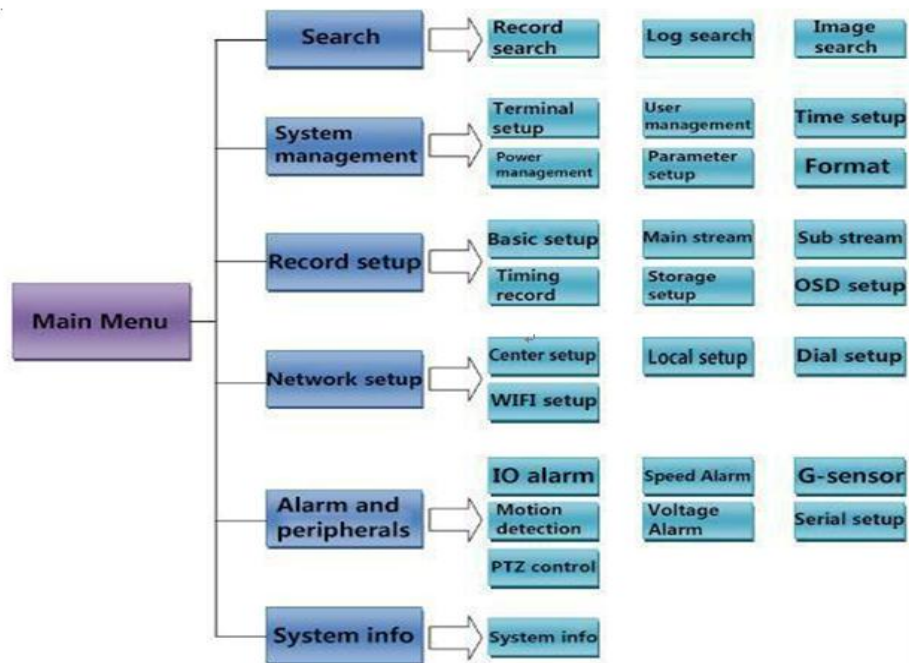

## 9. System operations

### 9.1. User login

For all devices, the default password for admin is **111111**; user is **666666**

#### With remote:

Press **【LOGIN】** button to login MDVR.

Press **【Enter】** button to call the keyboard page to input password.

If any err while inputting ,press **【Delete】** button to delete.

#### With USB mouse:

Please connect a USB mouse with MDVR to setup the menu.

Right click on the live video interface and you can see the login page.

Click on the password column to call the keyboard page to input password.



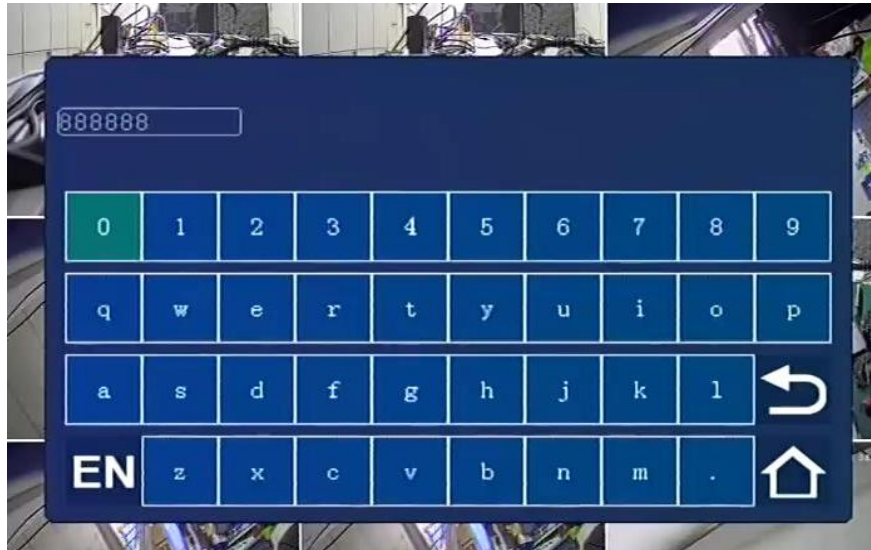

## 9.2. Main menu



### 9.2.1. Search

Searching menu includes: video search, log search and image search.

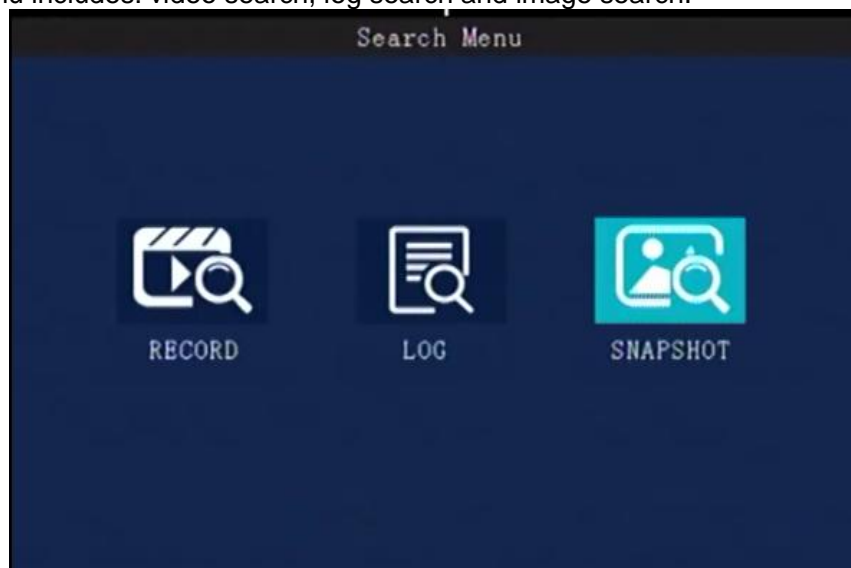

### 9.2.1.1. Video Searching



**Date:** Press number keys on remote to select the date, it defaults for the current day.

**Start time:** Press number keys to input the time, it defaults for 00:00.

**End time:** press number keys to input the time, it defaults for 23: 59.

**Video Type:** press **【Enter】** to select:



**REC-ALL** (all type of videos)

**REC- ALM**(alarm videos) contains

**IO**( I/O recording), **G sensor**, **Speed** ,**Move**, **Fatigue**,**OCC** type. Need set in the Alarm menu first.

**Disk Type:** press **【Enter】** to select: **main disk / mirror disk / disk backup**. it defaults for main disk. Regarding the difference , please check **[9.2.3.5 Storage setting]**.

**Search:** Move to the "**Search**" button, press **【Enter】** , then enter the search results interface.

The interface contains **record date**, **the current page** number , **menu for browsing**, search contents.

In the search contents, it contains : **DISK**(the file's location), **Type** (which you have selected) ,**start** and **end** time.



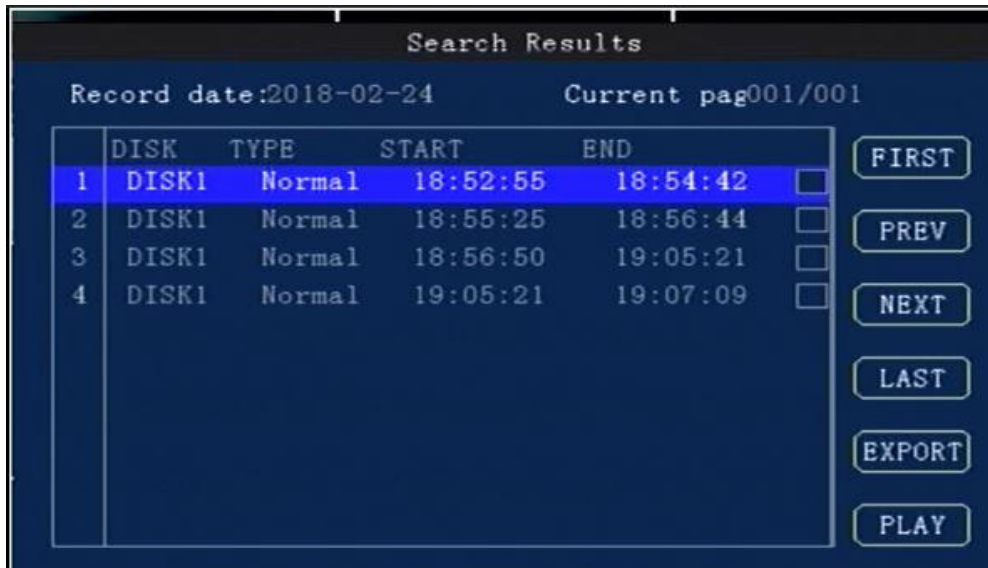

Press the **Arrow** keys to select the information you want to view, press **【Play】** on the remote or click **PLAY** to start playing the video, press the **【Return】** key to return the previous level.

Select the video file you want to view and press **【Enter】** key to check the video to be backed up.

Press the **Arrow** keys to select "**First**", "**Previous**", "**Next**", "**Last**", "**Play**", press **【Enter】** key to display the information page.

**Export:** Press **【Enter】** , the selected videos will be exported to an external USB storage device .

**Note:** If the selected period there is no video file and interface prompt: "**! This day has no video file**"

### 9.2.1.2. Log search

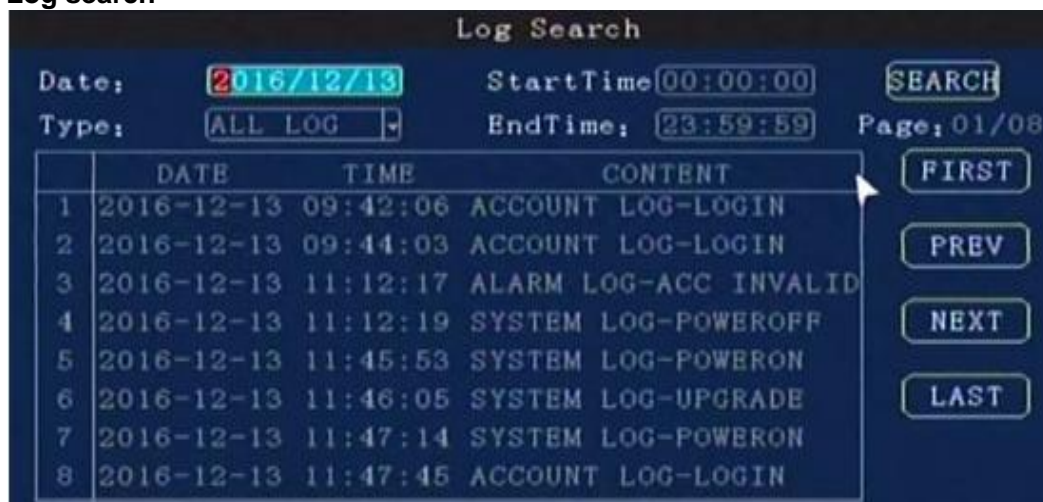

Log management record : power on/off, GPS timing, alarm event information, including event date, event time, and event name.

**Date Search:** Press number keys on remote to enter the date, default setting is today.

**Log Type:** Press **【Enter】** to select: All log/ System log /Configuration log/ Alarm log / Record log/Clear log/Operation log/Manage log. Default is all log.

**Start Time:** Press the number keys to enter the time, default is 00:00.

**End Time:** Press the number keys to enter the time, default is 23:59.

**Search:** Press **【Enter】** to select, search the log information from the start time to the end time.

Press the arrow keys to select "First", "Previous", "Next", "Last", press **【Enter】** to display the information page.

### 9.2.1.3. Picture search

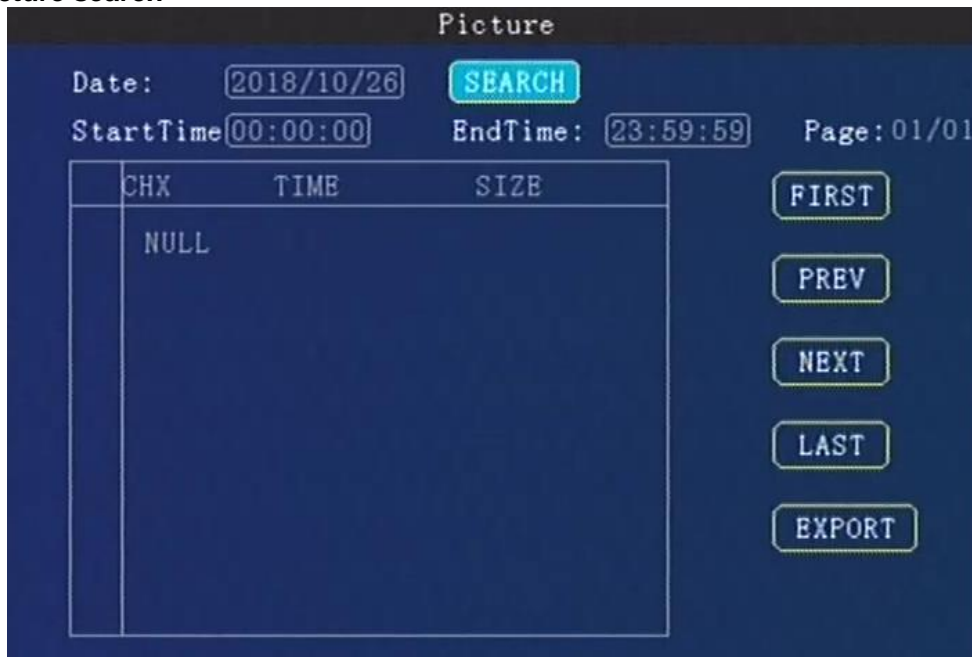

Pic search is used for checking the snapshot when alarm is triggering( I/O alarm and Video detect ) , should set in the alarm menu first.

**Search Date:** Press number keys to enter the date, default is today.

**Start Time:** Press the number keys to enter the time, default is 00:00.

**End time:** Press the number keys to enter the time, default is 23:59.

**Search:** Press **【Enter】** to select, search the log information from the start time to the end time.

Press the arrow keys to select "First", "Previous", "Next", "Last", press **【Enter】** key to display the information page.

**Export:** Press **【Enter】** , the selected pictures will be exported to an external USB storage device .

### 9.2.2. System setting



System setup menu includes: **Register info**, **User**, **Time**, **Startup**, **Config** and **Format**.

### 9.2.2.1. Register info

The CMS server will monitor and manage the vehicle by **Device ID**.

Regist Info

Dev ID: 88666666 Terminal:

Plate NO:  FactorID:

State :  TerminID: AD00000012A

Language ENGLISH City ID:

GuiAlpha: 0%

Position Mode : GPS+GL

License1  License2

SAVE

**Device ID**、Plate No., Province ID, Terminal Model, Factor ID, Terminal ID, City ID: Press number keys to input.

#### **Device ID**

**Set a number(12 digital at most) ,but must be unique, It's very important , since we will add this device to the server by these numbers.**

**Language:** press **【Enter】** to select and system will reboot automatically.

**Position Mode:**GPS, GLONASS, BeiDou, and so on.

**License1 &2:** Custom function of RFID function for driver, should input the license number. It's support for the third party platform with H-protocol.

### 9.2.2.2. User

User Management

Password: ON

USER:

Confirm:

ADMIN:

Confirm:

SAVE

**Password:** press **【Enter】** :On/Off

**ON:** Login with Admin password can setting the User &Admin password; login by user password can only set a user password, password must be the same with **[confirm]** below .

The administrator **can set or change the parameters**, so if you need to set some parameters, login with this account.

The user can search and view the files only.

**OFF:** Without password. When entering the menu, get into the main menu directly .

### 9.2.2.3. Time setup

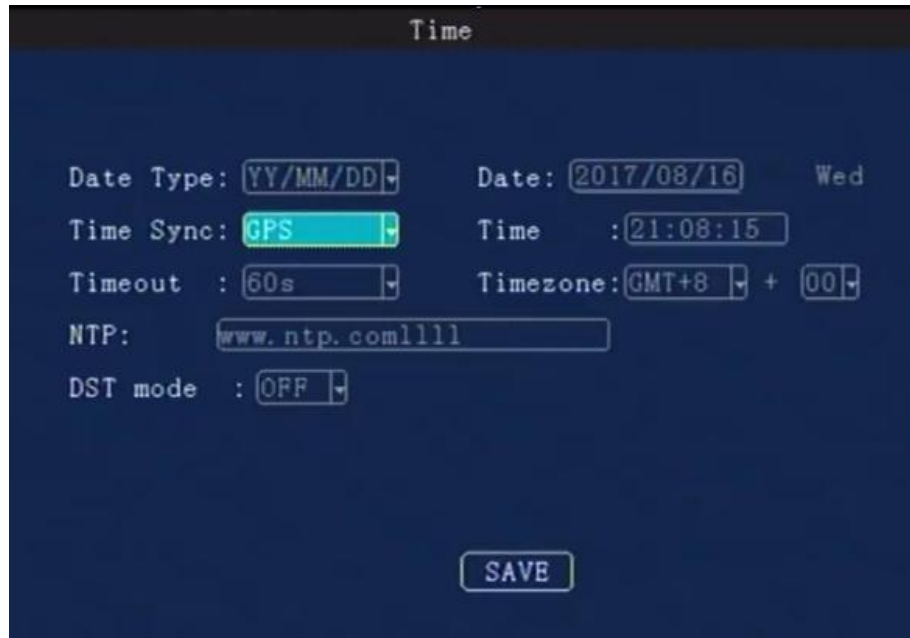

**Date Type:** Use for selecting the data type, year - month - day, day - month - year ,month - day - years. Press **【Enter】** to select.

**Time Sync:** Press **【Enter】** to select: Off / GPS / NTP, default is GPS.

**Time out:** Setup Menu Waiting Time, once overtime, it will automatically log off the current user,back to the monitoring mode. Press**【Enter】** to select: 1 minute / 2 minutes / 5 minutes / 10 minutes,Default is 1 minute.

**Date:** To modify current system date, press number keys to enter.

**Time:** To modify current system time, press number keys to enter.

**Timezone:** Press **【Enter】** to select a time zone, default is GMT + 08.

**DST mode:** Daylight Saving Time , set it according to your local area requirement.

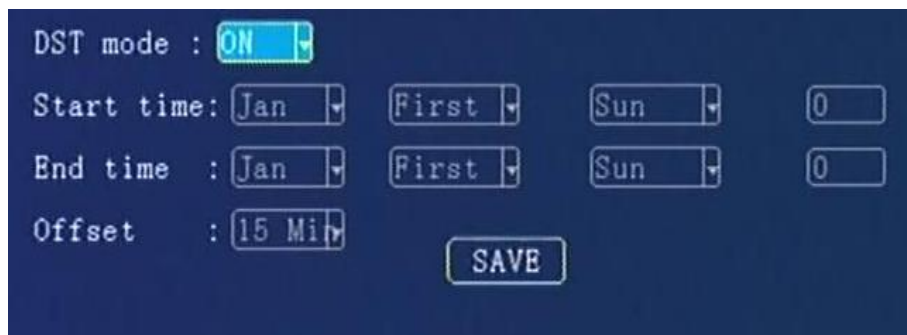

Select the start and end time, by week and the specific hour , then set the offset time (according to your local regulation, normally it's 60 minutes).

### 9.2.2.4. Startup

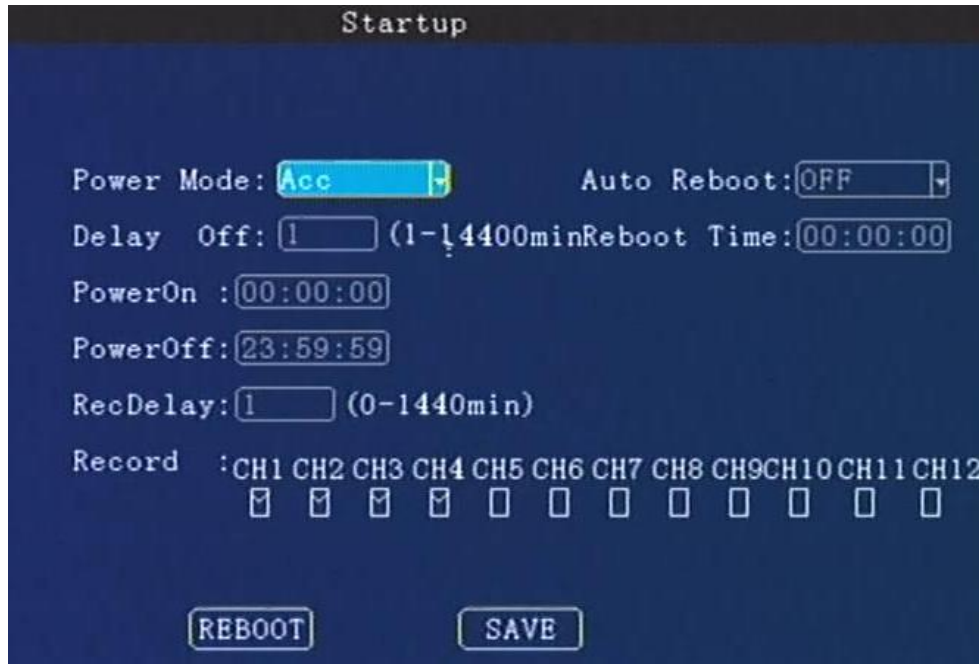

**Power Mode:** To set Power ON/Off mode, press **【Enter】** to select. Acc mode / timing mode.

**Timing mode:** on/off according to the user's setting period.

**Acc mode:** On/off by the vehicle's ACC ignition.

**Auto Reboot:** ON/OFF. The default is OFF. If it's **ON**, it will reboot at the **Reboot Time**.

If the device is running all the 24 hours, please set it **ON**.

**Delay off:** Set the device delay off time. MDVR will still work after the vehicle is power off, then turn off after **Delay-off** time, press **【DEL】** to clear the current number, press the number keys to change.

1440 minutes means the device will work all the time if the battery can support that long time. So please set a available parameter for it.

**RecDelay:** When the vehicle is power off, set the record delay time, it will continue recording during this time. This time can't exceed the **Delay off** time.

**Record :** Check the channels for delay recording.

**Power on:** Setup power on time under timing mode.

**Power off:** Setup power off time under timing mode.

### 9.2.2.5. Config

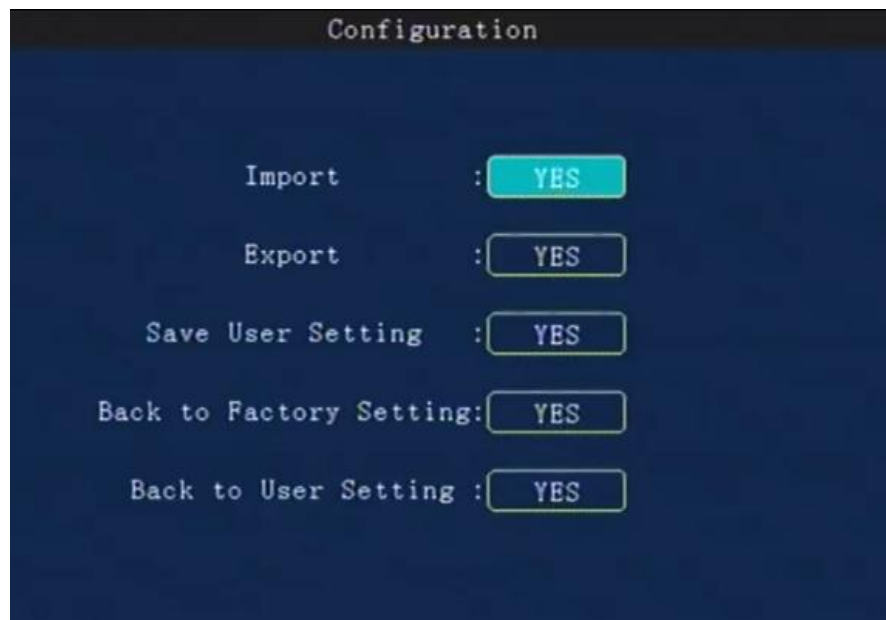



**Parameters import:** Import configuration information in the USB driver to the current device.

**Parameters Export:** Export all the configuration information of the current device to the USB flash driver. If there is no USB flash driver, it will be saved in the existing HDD/SD card.

**Tips:**

If you had set the whole parameters in one device already, you can export it first, and then import to other devices by this function. After the import, it will reboot automatically.

**Save User Setting:** Save all configuration information for the current user, it will store this information in the SD/HDD.

**Factory settings:** Restore some device parameters to factory default, such as Alarm, Record. It will not change the Register and Network setting.

**Back to User settings:** Restore all device parameter setting to saved user's setting

### 9.2.2.6. Format



Press the arrow keys to select **DISK1 / DISK2 / USB** (if you had plugged the USB driver).

It will display the whole available disks. Size/Std size/Block setting.

**Encryption:** For safe concern of videos, we can set a password (KEY) for the dedicated channels. When played by our player, it will ask the user to input the password.

**STD size:** The area for saving Alarm pictures, debug Logs, system file, Alarm videos. This area is which you can check on the PC. For example, if you need more space for saving alarm videos and upload to FTP server, should change it. Just input a new value in **StdPart(GB)** and **SAVE** it.

**Block(MB):** All videos are saved by block read&write technology. It's not recording by time length. So if you need save a long time period video, change a bigger value for it.

**Format:** If there is some error with the disk, format it. It will take about some minutes.

Besides, you can also evaluate the disk space for recording.



### 9.2.3. Record



Recording setup including: **General, M-stream, S-stream, Time recording, Storage, OSD set.**

### 9.2.3.1. General

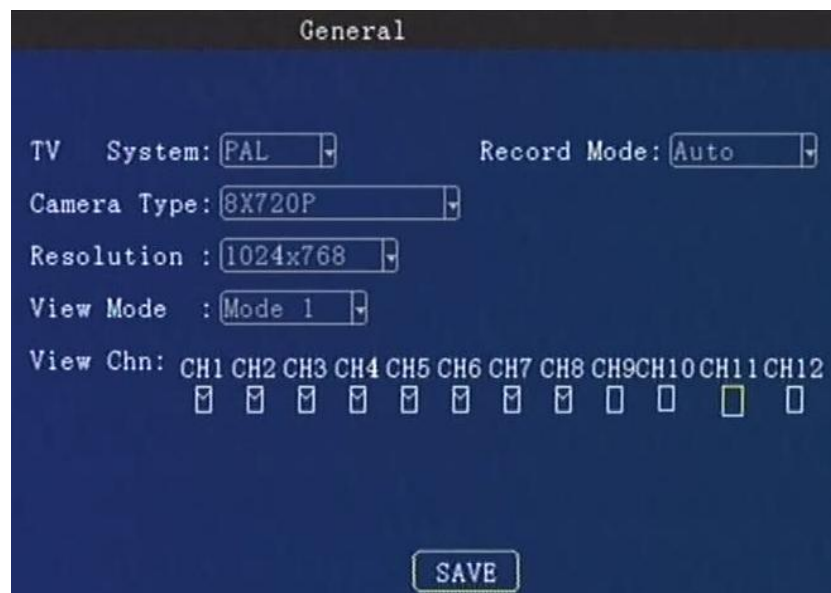

The General info contains the basic setting for camera. When you install the MDVR, please double-check these sub-menu .

**TV System:** Press **【Enter】** to select: PAL / NTSC, default is PAL. If it's wrong ,the image will become black-white color only. **Select PAL/NTSC according to the camera's video type. Device will automatically restart after changing it.**

**Camera Type:** Press **【Enter】** to select:  
 8\*1080p, 8\*720p,4\*1080p+4\*D1, 4\*720P+4\*D1, 2\*1080P+6\*720P and so on.  
 Resolution : **D1**:720\*576, **720P**: 1280\*720 . Set it according to the camera type.  
Generally speaking, 2MP is 1080P, 1MP is 720P mode, D1 definition is less than 1MP.

**Attention:** this setting must be same with cameras, or else , it will not display video.

**For example:** You have 4\*1080P and 4\*D1 cameras , choose 4X1080P+4XD1 item, You must put the 1080P in channel 1/2/3/4, put D1 in channel 5/6/7/8.

**Record Mode:** Press **【Enter】** to select: Auto / time recording / alarm recording, default is Auto.  
**Auto:** it will record all the time.  
**Time recording:** Need set the time in **[9.2.3.4 Timed Record]**.



**Alarm:** Only record when alarm is triggering, should set in the Alarm menu first.

**Display Resolution:** This is set the TFT screen display resolution. Press **【Enter】** to select: 720 x 576/1024 x 768/1280 x 720/1920\*1080.

**View mode:** Press **【Enter】** to select: Two / Four / Six / nine

**View Chn:** Select the channels you need ,default setting is all channels.

### 9.2.3.2. Main stream

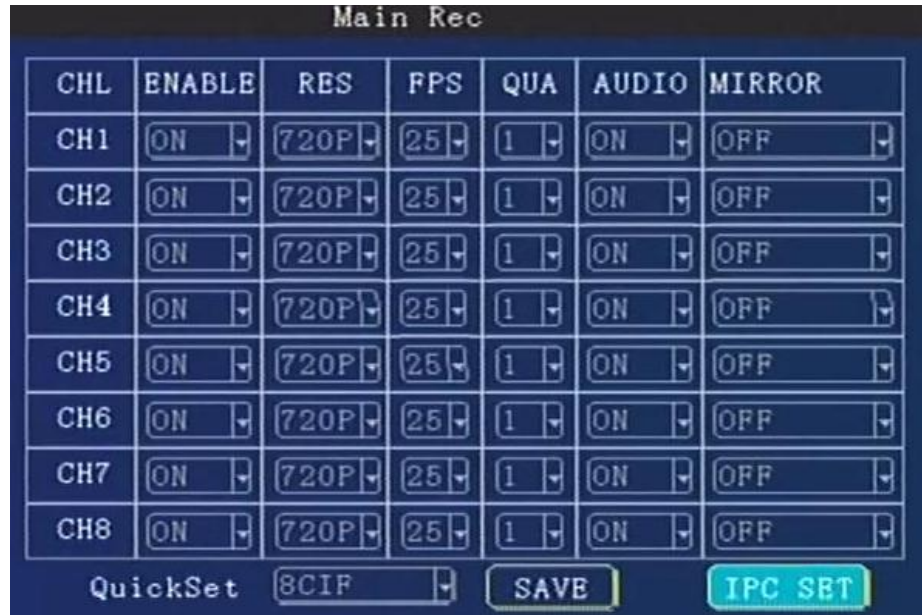

**Enable:** Press **【Enter】** to select: On / Off.

**Res:** Resolution ,press **【Enter】** to select: D1 / HD1 / CIF / 720P.

**CIF:**352\*288,**HD1:**352\*576, **D1:**704\*576, **720P:**1280\*720 .

**FPS:** Frames per second , More frames, every picture will be more clear. press **【Enter】** to select: 1-25 .  
NTSC : 30FPS , PAL: 25FPS.

**QUA:** Quality of the video, press **【Enter】** to select: 1-8. **1** is best , but it will cost more storage space.

**AUDIO:** Press **【Enter】** to select: On / Off. **ON** means the audio will be saved with video together.

**Mirror/Flip:** Set the image to mirror or flip .Press **【Enter】** to select the types.

**QuickSet:** Setup all channels resolution simultaneously, press **【Enter】** to select: 720P/D1 / HD1 / CIF / 720P.

**IPC test:**Supports 4 IPC by a PON switch.

We will provide special manual for this.



**Attention:** Please keep the **EN** menu as **OFF** if there is no IPC camera.

### Storage Calculation

MDVR support dual streams.

Main stream is mainly used for local recording; Sub-stream is mainly used for network transmit.

#### Main stream:

Resolution	Image Quality Level	1	2	3	4	5	6	7	8
Bitrate [Kbps]	1080P	8192	7168	6144	5120	4096	3072	2048	1536
	720P	4096	3584	3072	2560	2048	1536	1024	800
	D1	2048	1536	1230	1024	900	800	720	640
	HD1	1280	960	768	640	560	500	450	400
	CIF	800	600	480	400	350	312	280	250

Resolution	Image Quality Level	1	2	3	4	5	6	7	8
Bitrate [MB/hour]	1080P	3600	3150	2700	2250	1800	1350	900	675
	720P	1800	1575	1350	1125	900	675	450	351
	D1	900	675	540	450	395	351	316	281
	HD1	562	422	337	281	246	219	198	176
	CIF	351	264	211	176	153	137	123	110

#### Sub stream:

Resolution	Image Quality Level	1	2	3	4	5	6	7	8
Bitrate [Kbps]	D1	1500	1300	1100	900	800	700	600	500
	HD1	1300	1200	1000	800	700	600	500	400
	CIF	512	450	400	350	320	280	250	220

Resolution	Image Quality Level	1	2	3	4	5	6	7	8
Bitrate [MB/hour]	D1	659	571	483	395	351	307	264	219
	HD1	571	527	439	351	307	264	219	176
	CIF	225	198	176	153	140	123	109	96

Now take the Main-stream(Sub-stream is used for uploading) table for example.

It is an approximate data for **one camera in one hour**, eg. **720P**, if the **Quality is 1** (best), from the table, we know it will take up **1800MB /hour**.

For example, suppose it has **4** cameras, and work **10** hours everyday in one month (**30** days).

**Total= 1800MB\*4(cameras)\*10(hours)\* 30(days)=2160000MB ≈ 2109GB. And you need a 2TB HDD at least.**

#### 9.2.3.3. Sub stream

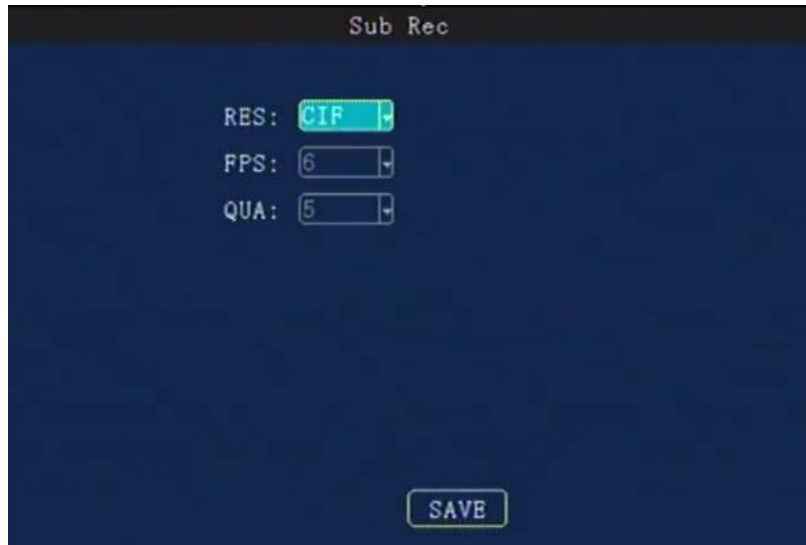

The sub-stream is used for live streaming. The higher Resolution, bit rate and frame rate, video will be more clearer, but need more 3G/4G data.

**Notice:**

1. Currently **3G** networks support **CIF** real-time network transmission, the default setting is **CIF**.
2. **QUA, 1 is best**, for saving the 3G/4G data. Please choose 7 or 8.

**9.2.3.4. Timed recording**

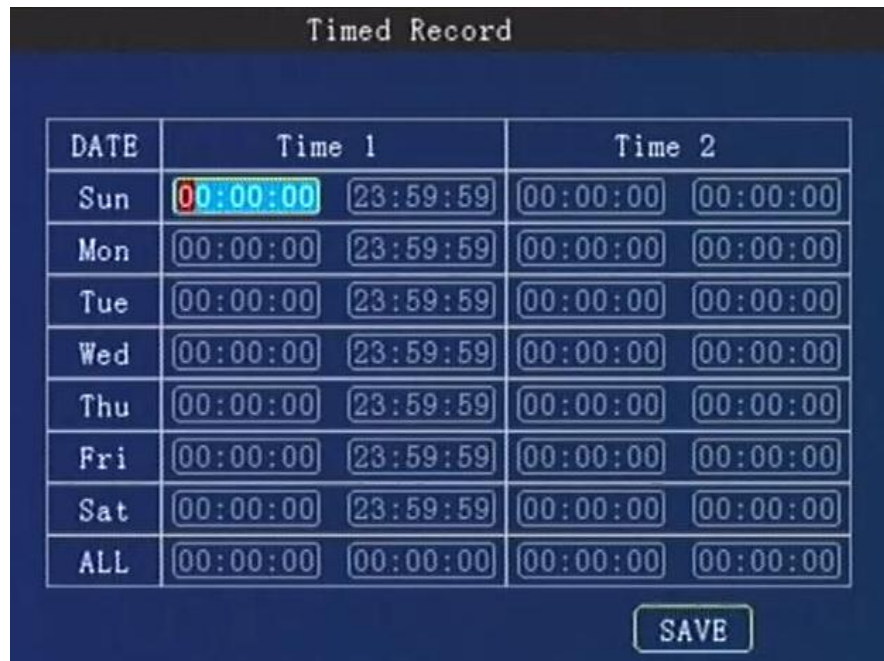

Setting the **start time** and **end time** of timing record, press number keys to enter. During the setting time, it will start recording automatically.

**Attention:**

1. Need turn on the **Time** mode first, in the **MENU--General--Record Mode**



2. Set the **ALL** as **00:00:00-00:00:00**, or else, the timed recording will not work!
3. Set the recording plan for every day.

### 9.2.3.5. Storage setting



**Alarm Previous Rec:** Set the previous recording time before the alarm happens. Press number keys to enter, 0 to 60 seconds for selection.

**Alarm delay:** Set the delay recording time after the alarm happened. Press number keys to enter, 0 to 3600 seconds for selection.

**Alarm file to server:** Alarm file save to CMS or FTP. All alarms file will be uploaded at real-time. So pay attention if it's linked by 3G/4G, since it will cost data of SIM card.

**CMS** is default setting, it will be saved in **the Storage Server of CMS**.

**FTP:** It will upload to the FTP server of CMS or your own FTP server(need build it first).

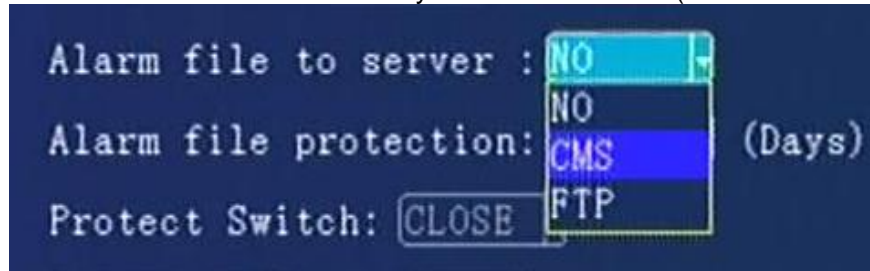

**Alarm file protection:** Set the alarm file protection time, this files will be not deleted during the setting days. Press number keys to enter, 0 to 45 days.

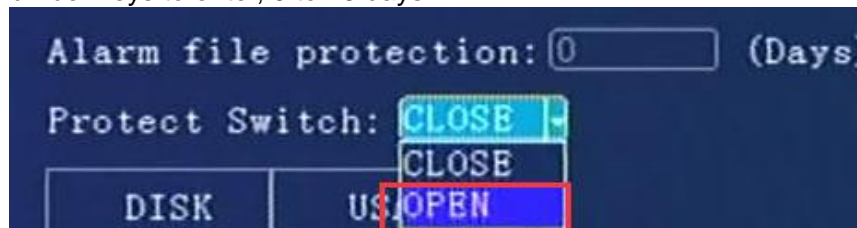

**Protect Switch:** Close or Open. When it's open, then you can set the **Alarm file protection's** days(it will not be covered in HDD/SD until that days). And select the alarm type , such as I/O ,G-sensor ,speed, Fatigue ,voltage and so on.

**Attention:** *In order to upload files to FTP or CMS storage server.*

1. Must turn on the Protect Switch OPEN. And set the Alarm file protection days.
2. Set a Big space for StdPart (such as 2G/4G size) in 9.2.2.6 Format.

**Disk and Usage:** Press **【Enter】** to select: No / Record / mirror / Backup.

**No:** No recording; **Record:** Recording the file in this disk.

**Mirror:** Save the recording video in this disk at same time.

**Backup:** When the current recording disk is failed, the system will save the video in this disk.

### 9.2.3.6. OSD Set



Set the stamp information on the image , and location to be displayed on the image.

**Time:** Press **【Enter】** to select Enable: on / off, press number keys to enter the X and Y coordinates.

**Plate:** Press **【Enter】** to select Enable: on / off, press number keys to enter the X and Y coordinates.

**GPS:** Press **【Enter】** to select Enable: on / off, press number keys to enter the X and Y coordinates.

**USR DEF:** Press **【Enter】** to select Enable: on / off, press number keys to enter the X and Y coordinates.

**USER Define:** You can define every channel a name by yourself, press **【Enter】** to call out the keyboard, and input the characters , **12 characters at most**.

### 9.2.4. Network Setting(Not available for ME40-04)



Network Setup menu includes: **Center** settings, **Local** settings, **Dial** settings and **WiFi** settings. The device access the CMS server or third party platform by these method .

Network priority is **WiFi>3G/4G>LAN**, it will switch automatically according to the network status.

#### 9.2.4.1. Center settings



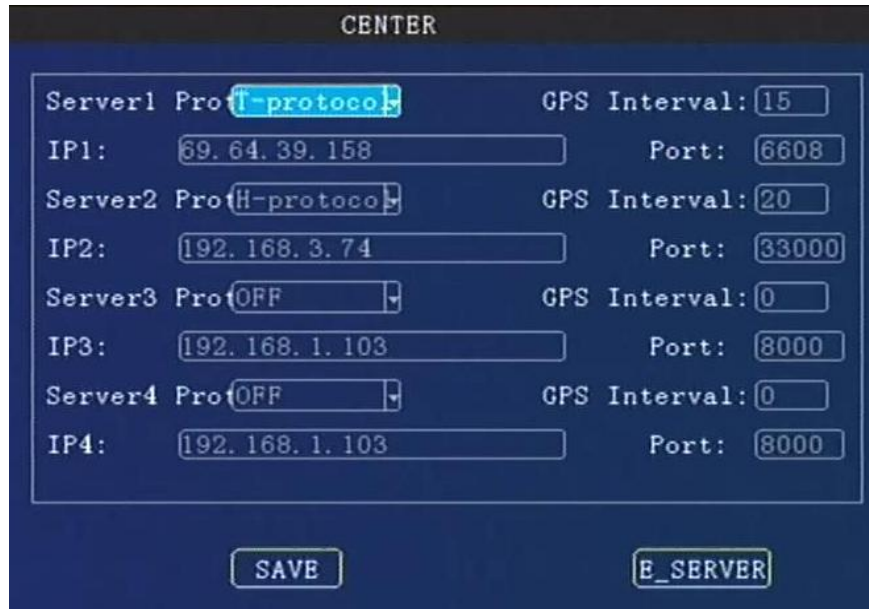

Our MDVR supports 2 system platform at the same time. You can choose one of them to test.

**Server1:** CMS platform. Input your CMS server PC's WAN or LAN IP address for test. **Port:** The default port is 6608

**Server 2:** The third party server address. Such as FMS platform.

**Server3/4 :** Transport server. For uploading the raw data of external devices via RS232 or RS485.

**Server Protocol:** It's the protocol used to connect the center server.

For server1 protocol: **T-protocol** is default setting .Don't change it!

For server2 protocol : It contains H-protocol ,R-protocol, Transpt, etc. **.H-protocol** is Howen protocol (our own protocol) if you need to link the third party FMS platform.

**GPS Interval:** The time interval for sending the GPS data package(contains GPS, speed, alarm ,time&date and so on. The device will send the data package to platform.

**If you need save the data of SIM card, set a long time.**

#### FTP server



Input the FTP server IP address, port .User and password. You can build your own FTP server. **StatePort** is for maintenance(still under development).

If you have set in **9.2.3.5 Storage setting** and choose the FTP, all alarms file will be uploaded to FTP server.

For **FTP** : IP is CMSserver's WAN IP address. Port: **2121**

User: **admin**

Password: **cmsserverv6**

### 9.2.4.2. Local Network Setup



#### Local network IP

LAN is used for local connection or IPC connect.

The device supports LAN connect directly like as your PC. Set the same IP segment with your PC 's address(include IP, Mask, Gate, DNS address. For MAC, just use our default setting address,don't change), otherwise, it can not be connected. The LAN indicator will be lit. If your don't know this information, ask for your ISP supplier or IT team for help.

When connect the IPC camera, make sure the IPC's address in the same segment with LAN. For example, if the LAN address 192.168.1.010, the IPC address could be 192.168.1.100, they are in the same **192.168.1.xxx** segment. Or else, it can not link the IPC.

### 9.2.4.3. Dial settings



**Enable:** Press **【Enter】** to select: On / Off.

**Net Type:** Press **【Enter】** to select: WCDMA / EVDO / TD-SCDMA / TDDLTE / TDDLTE-1 / TDDLTE-2.

**APN.:** Set for access the internet, it will not transmit the video if set wrong .

**Notice:** Each telecom supplier has a different APN , please ask the local supplier first.

**Center No. :** Default setting is \*99#. Please inquiry your supplier if any change.



**User name, Password:** set up a 3G/4G service user name and password. Also should inquiry your SIM card supplier!

#### 9.2.4.4. WiFi settings

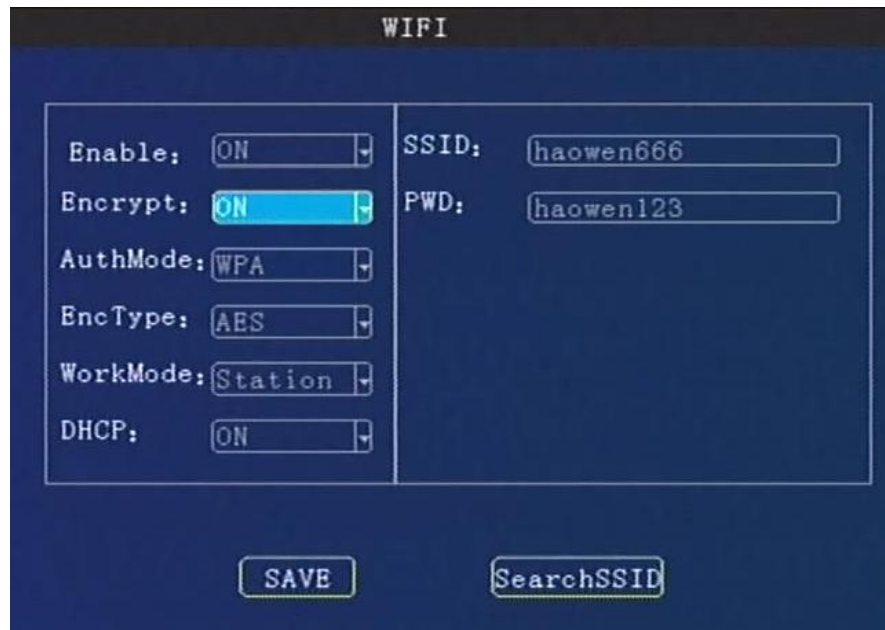

**WiFi Enabled:** Press **【Enter】** to select: On / Off.

**Enable Encryption:** Press **【Enter】** to select: On / Off.

**Authentication Mode:** Press **【Enter】** to select: Open / Shared / WPA / WPA-PSK.

**Encryption Type:** Press **【Enter】** to select: NONE /WEP/ TKIP / AES.

**Work Mode:** Station or AP. Station is default setting ,which enable the device link the internet or router 's wireless signal.

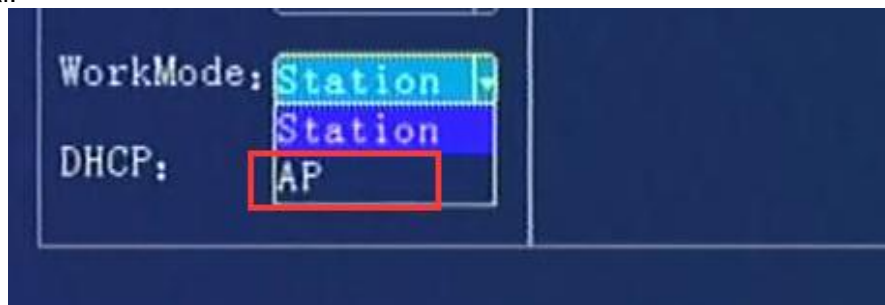

**AP:** Access point mode, the device will share a hot-spot for other devices .

Besides, user can set the parameters by our APP or mobile checker.

**DHCP:** Dynamic Host Configuration Protocol. **OFF:** Input the IP address manually. **ON:** Get the IP address automatically.

**SSID, password :** Input your own router's wireless signal name and password.You can click **Search SSID**.

**IP, Gate, Mask :** If the DHCP is off, you need to set this manually.

WiFi IP segment should be different with LAN IP.

## 9.2.5. Alarm



Alarms include: I/O alarm, speed alarm, G-sensor, motion detection, alarm voltage, Fatigue, serial port and PTZ control management.

### 9.2.5.1. IO Alarm

IO					
NO	Enable	Level	Delay	Wait	Linkage
IN1	Panic	H	0	5	LINK_SET
IN2	OFF	H	0	5	LINK_SET
IN3	OFF	H	0	5	LINK_SET
IN4	OFF	H	0	5	LINK_SET
IN5	OFF	H	0	5	LINK_SET
IN6	OFF	H	0	5	LINK_SET
IN7	OFF	H	0	5	LINK_SET
IN8	OFF	H	0	5	LINK_SET
IN9	OFF	H	0	5	LINK_SET

IN1-IN6 is for generally use (same with the I/O serials cable ), IN8 and IN9 are for iButton, it must be OFF status if you don't use them. (on I/O serials cable , it is IN7 and IN9)

**Enable:** Press **【Enter】** key to select: off / emergency / front door / middle door / back door / driver door / other doors / low beam light / high beam light / turn right light / turn left light / brake / back / Customer definition(Press **Info** key to call out the keyboard for new firmware).

**Level:** Press **【Enter】** to select: high / low.

**High** means it will trigger sensor alarm when the voltage of sensor input is changed from 0 to a high voltage[DC 4V - 12V].

**Low** means it will trigger sensor alarm when the voltage of sensor input falls from a high voltage[DC 4-12V] to 0 .

**Delay:** The alarm duration time after trigger source is removed, it is used for setting linkage's duration time. During this period, it will not response the new alarm if there is a continuous triggering on the I/O port.

**Wait:** The waiting time for trigger in case of mistaken touch.

**Record:** Press **【Enter】** to select: On / Off, enable when the alarm happens, it will record or not.

**Linkage:** Press **【Enter】** to select: **OFF/Output 1 / Output 2 / Buzzer/snap-up.**

**Output1:**Output1 cable will output a DC12V voltage when alarm is triggered.

**Output2:**Output2 cable will output a DC12V voltage when alarm is triggered.

**Buzzer:**Need PCB support this component.

**Snap-up:** It will capture the picture while alarm is triggering . And save in the SD/HDD.

**Preview:** Press **【Enter】** to select the channel. When the alarms happen, it will pop-up the setting channel 's image on the TFT screen .

For **Linkage**

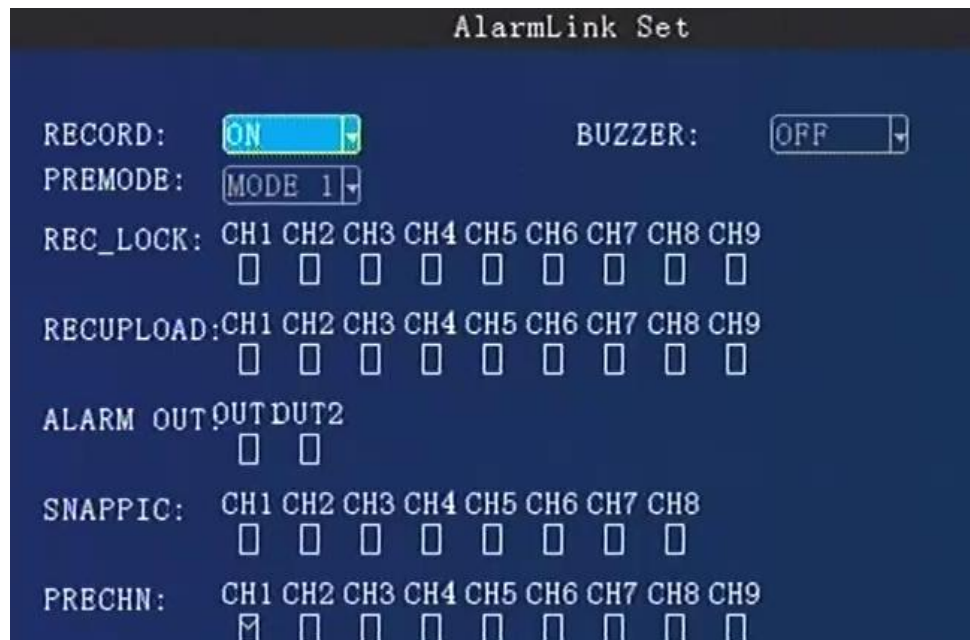

**RECORD:** ON.

**REC\_LOCK:** The alarm files will be locked in case of been deleted.

**ALARM OUT:** Choose output1, output2.

**SNAPPIC:** Take a snapshot. The picture will be saved in the device storage.

**PRECHN:** Preview channel when the alarm is triggered.

### 9.2.5.2. Speed Alarm



It contains **Parking**(parking time setting), **L-Warn**(low-speed warning), **L-ALM**(low-speed alarm), **H-Warn**(high-speed warning), **H-ALM**(high-speed alarm), **Spd Up**(speed up) ,**Spd Down**(speed down) these seven items.

Set the parameters refer to the following text. When it break the rule ,it will trigger an alarm.

For example , **L-ALM**(low-speed alarm), set it **ON** and the **Limit** value and other settings. If the vehicle run a speed lower than the **Limit** value , it will trigger the alarm.

**Enable:** Press **【Enter】** to select: On / Off.

**Limit:** Set a speed value for system judgement.

**Delay:**Linkage's duration time. Press number keys to set. **During this period, it will not response the new alarm if there is a continuous triggering.**

**Wait:** The waiting time in case of mistaken judgement or just wait.Press number keys to set.

**Record:** Turn on/off recording function.Press **【Enter】** to select: On / Off.

**Alarm link:** Press **【Enter】** key to select: **OFF / Output 1 / Output 2/Buzzer.**

**Speed Source:** Press **【Enter】** to select: GPS / Vehicle / Mix.

**Pulse:** Access through SPEED-A, SPEED-B operator to take the pulse factor. This function need an external pulse sensor device.

**Speed unit:** km/h, MPH, nm/h for option.

For **Parking**, the Limit is also speed, you need set a speed first, if the vehicle under this speed, the device will deem it's parking.

For **speed up/down**, set a value for it. If the vehicle harsh-accelerate or harsh-brake, the system will compare the current speed with the previous second's speed all the time. If the change value more than the setting parameter, It will trigger an alarm.

### 9.2.5.3. Acceleration



The acceleration alarm first need to get coordinate correction, the vehicle may be parked on level ground to clear calibration.

**Tilt:** it refers to a device rollover angle, unit is degree.

**Enable:** Press **【Enter】** to select: ON/OFF.

**Limit:** Set a limited value for system judgement.Press the number keys to enter.

**Wait :** The waiting time in case of mistaken judgement . Press the number keys to enter.

**Record:** Turn on/off recording function.Press **【Enter】** to select: On / Off.

**Alarm link:** Press **【Enter】** to select: **OFF / Output 1 / Output 2/Buzzer.**

**Delay:**Linkage's duration time. Press number keys to set.

**Adjust:** *After you install the device, press this button to refresh all parameters to zero.*

#### 9.2.5.4. Motion Detection

For saving the space of the disk, you can turn on the motion-detect function. It will record only when camera has detected the movement objects or actions.

Besides, it also supports Occlusion alarm function. You can only choose one of them between Motion detect and video Occlusion at the same time.





**Enable:** Press **【Enter】** select: ON/MOVE/OCC.

**Limit:** Set the threshold of video area/detection area percentage . Suggest 65.

**Sense:** Sensitivity , it decides the detection sensitivity level .Press **【Enter】** to select: 1-8.

**1 is the highest level.** Suggest to use 3.

**Record:** Turn on/off recording function.Press **【Enter】** to select: On / Off.

**Alarm linkage:** Press **【Enter】** to select: **OFF/Output 1 / Output 2 / Buzzer/snap-up.**

**Delay:**Linkage's duration time. Press number keys to set.

**Attention:**

- 1.Regarding the occlusion/motion detect function. we suggest choose 4 channels at most.
- 2 After you set the parameter, please restart the device.

**9.2.5.5. Voltage alarm**

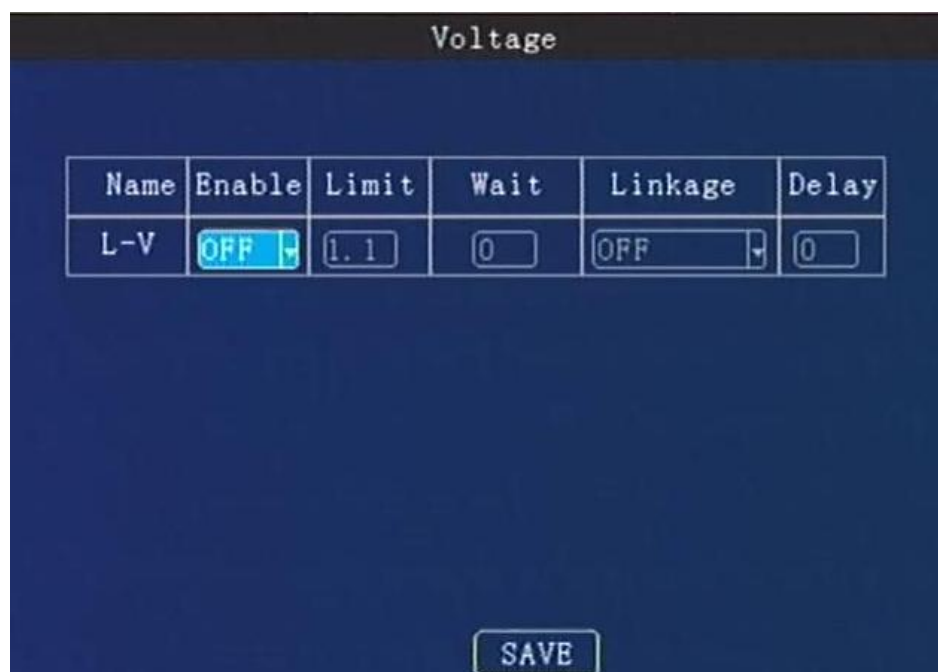

If the operation voltage is low, it will trigger the alarm. The system can work at 8-36V (The lower voltage, the more current demanding), it's better work at 12/24V. So you can set a **Limit** value first.

**Enable:** Press **【Enter】** to select: ON/OFF.

**Limit:** Set the threshold of voltage level .Press the number keys to enter.

**Wait:** The waiting time in case of system mistaken detection . Press the number keys to enter.

**Alarm linkage:** Press **【Enter】** key to select: **OFF / Output 1 / Output 2/Buzzer.**

**Delay:**Linkage's duration time. Press number keys to set.

### 9.2.5.6. Serial



Name	External	Baud	DataB	StopB	CheckB
COM1	OFF	4800	8	1	None
COM2	OFF	57600	7	1	Odd
COM3	OFF	9600	8	1	None

SAVE

**Com port** means the RS232 and RS485 communication ports, it's used for connecting the accessory, such as fuel level detection, IC card reader, fatigue driving camera, people counting etc. For HDD type's device, COM1 & COM2 is RS232, COM3 is RS485.

**Attention:**COM1 is for RX1/TX1, COM3 is for RX2/TX2.

For different external device, the setting is different. We will provide the corresponding installation manual for reference.

**External:** Press **【Enter】** to select accessory type.

**Baud Rate:** Press **【Enter】** to select: 600/1200/1800/2400/4800/9600/19200/38400/57600/115200

**Data Bit:** Press **【Enter】** to select: 6/7/8

**Stop Bit:**Press **【Enter】** to select: 1/1.5/2

**Check Bit:** Press **【Enter】** to select: Even/Odd/None/Mark/Space

### 9.2.5.7. PTZ Control





It's used for setting the PTZ device when control a PTZ camera(Press the **PTZ** button on the remote, then press **+ /-** button).

**Protocol type:** Pelco-D/Pelco-P for option.

**Address code:** Set a different address code for each channel, the MDVR will recognize this address and control it. Press number keys to enter.

**Preset: Preset location** when the system start-up. You can set the PTZ lots of the location first, and then choose one of them as the preset location.

#### 9.2.5.8. Fatigue Driving



For fatigue driving function, it's still under development.

#### 9.2.6. System Info

The shortcut key is **info** key on the remote, press **UP** or **DOWN** key to switch the information interface. It will show the whole information about the device status.



The important information as following:

**MCU version** : CPU firmware version

**APP Version**: The current firmware version.

**System power**: The device current operation voltage.

**Phone NO.:** Device ID actually.

**I/O status**: Check the I/O electrical level status. **1** is high, **0**(lower than 3V) is low. You can check after device had connected an I/O device, such as, a panic button.

**G-sensor**: It shows the G-sensor value. Move the MDVR check if this value is changing.

**GPS info** : It will show as **GPS[\*N] + Location** data, **N** is satellite numbers, more than 3 is normal.

**No work**: there is no GPS signal.

**None/Not exist**: GPS module is not detected by device. Please restart device or update firmware to try.

Click **NEXT**, it will display the Net information

In the info2 interface :

**Net linked** : Show the current connection method :

**Inner WIFI** (the device is linking with WIFI) , **3G**( the device is linking with 3G).

**Wired**(the device is linking by net cable)

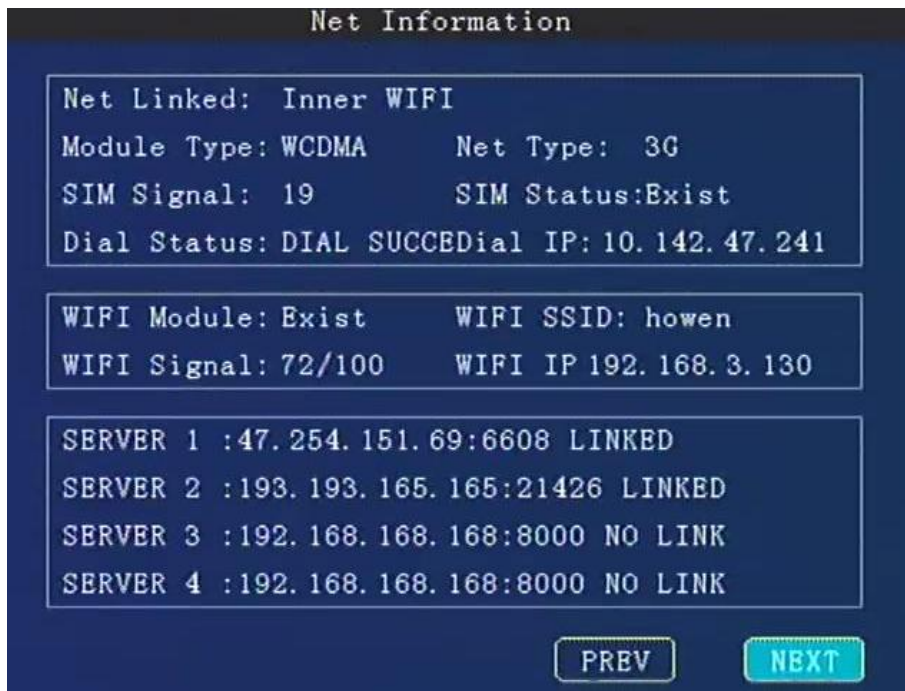

**3G/4G:**

**Module Type :**WCDMA/FDD-LTE/TD-LTE

**SIM Signal:** Signal intensity.

**SIM status:** If there is no SIM card or the system have not detected the SIM card, it will show **Not exist**.

**Dial status:** Dial Fail or success.

**Dial IP:** If dial success, it will show the dial IP address. If failed, you should check the **10.2.4.3 Dial setting**.

**WIFI:**

**WIFI module :**Exist or not exist.

**WIFI SSID:** Show the current linked WIFI SSID.

**WIFI signal:** WIFI signal intensity ,100/100 is best.

**WIFI IP:** If the device had linked the wireless network, it will get a IP address.

**Server 1/2:** Check if the CMS server IP has linked. If it show **NO LINK** , you will not be able to view the video on the CMS Client.Then you need to check the **10.2.4 Network Setting** menu, include the center IP and port, and WIFI/LAN/3G/4G menu.

Click **NEXT**, it will display the disk information;

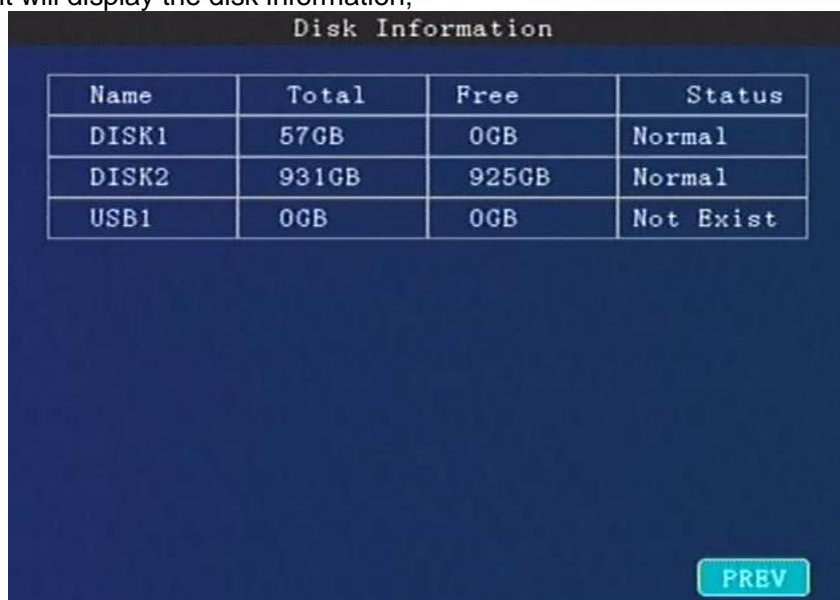

**Disk storage :** Check the status of disk or a USB storage driver .

***If there is problem with device , please check these information interface first.***



#### **FCC Statement**

**Changes or modifications not expressly approved by the party responsible for compliance could void the user's authority to operate the equipment.**

**This equipment has been tested and found to comply with the limits for a Class B digital device, pursuant to Part 15 of the FCC Rules. These limits are designed to provide reasonable protection against harmful interference in a residential installation. This equipment generates uses and can radiate radio frequency energy and, if not installed and used in accordance with the instructions, may cause harmful interference to radio communications. However, there is no guarantee that interference will not occur in a particular installation. If this equipment does cause harmful interference to radio or television reception, which can be determined by turning the equipment off and on, the user is encouraged to try to correct the interference by one or more of the following measures:**

- Reorient or relocate the receiving antenna.**
- Increase the separation between the equipment and receiver.**
- Connect the equipment into an outlet on a circuit different from that to which the receiver is connected.**
- Consult the dealer or an experienced radio/TV technician for help**

**This device complies with part 15 of the FCC rules. Operation is subject to the following two conditions (1) this device may not cause harmful interference, and (2) this device must accept any interference received, including interference that may cause undesired operation.**

**This equipment complies with FCC radiation exposure limits set forth for an uncontrolled environment. This equipment should be installed and operated with minimum distance 20cm between the radiator & your body**