

COSCO®

SIMPLE

SMART

FUN



To see installation videos,
scan the QR Code or
visit www.coscokids.com.

COSCO®

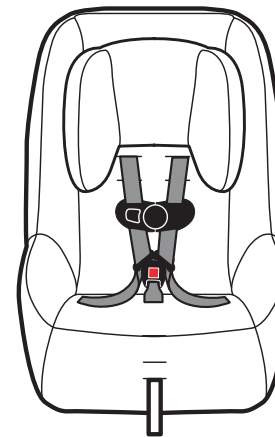

4358-7784
5.14.19



MIGHTY FIT 65 MIGHTY FIT 65 DX, LX CONVERTIBLE CAR SEAT

KEEP INSTRUCTIONS FOR FUTURE USE.
Read all instructions before using this car seat.

 **WARNING:** Failure to follow the warnings on the labels and in the instruction manual can result in serious injury or death to your child.

Overview

Welcome to the Cosco family and thank you for choosing this car seat, also known as a child restraint!

To help you get started using your child's new car seat, here are the 4 main tasks you'll need to complete.



Measure Your Child



Adjust the Car Seat to Fit Your Child



Install the Car Seat into Your Vehicle



Secure Your Child in the Car Seat

Your child's safety is worth the time it will take to read and follow these instructions.

Ready? Let's go!

Pages 1-4 will introduce you to the parts of the car seat.

Page 66 has our contact information. If at any point you would like assistance, please feel free to reach out to us.

Quick Navigation

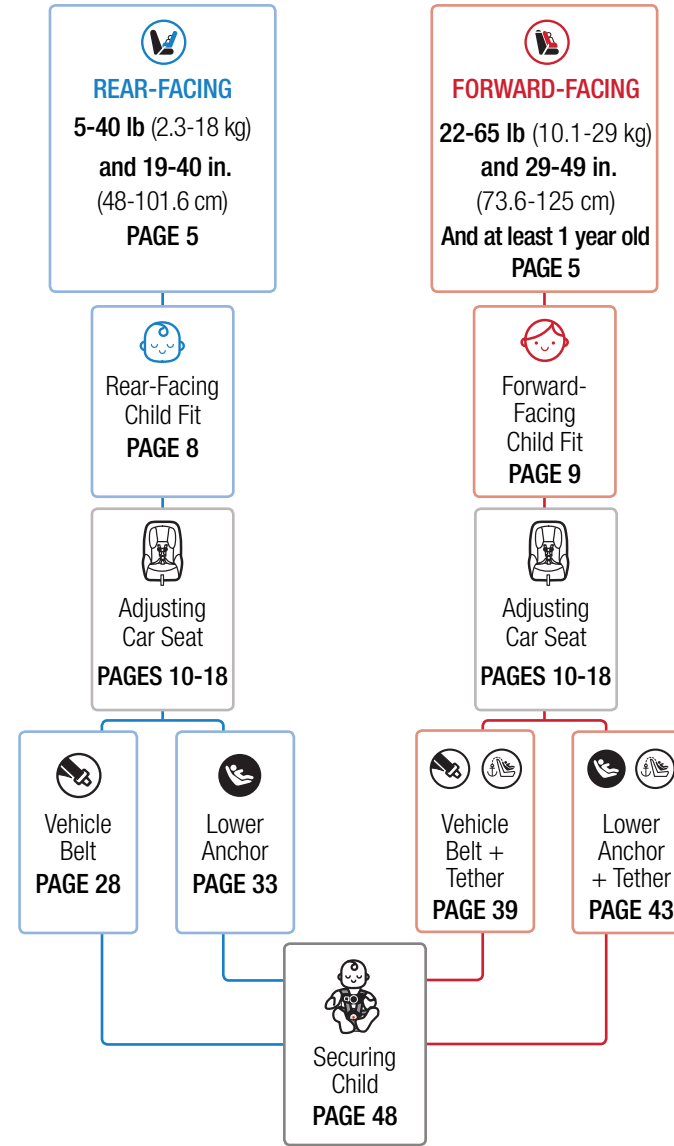

Contents

Getting Started

Parts of the Car Seat	1
Accessory Use	3
Choosing Car Seat Mode	4
Preparing Car Seat for Child Fit.....	6
Rear-Facing Child Fit	8
Forward-Facing Child Fit.....	9

Making Adjustments to Car Seat

Changing Harness Height and Headrest Height	10
Changing Buckle Position	13
Harness System Adjustments for Smaller Infants	15
Reclining the Car Seat	18

Choosing LATCH or Vehicle Belt

LATCH: Lower Anchor Use	19
Vehicle Belts	21
Tether Use	25

Installation in Vehicle

Rear-Facing Mode	27
Rear-Facing Vehicle Belt Install.....	28
Rear-Facing LATCH: Lower Anchor Install	33
Forward-Facing Mode	38
Forward-Facing Vehicle Belt + Tether Install.....	39
Forward-Facing LATCH: Lower Anchor + Tether Install.....	43

Securing Child in Car Seat	48
---	----

Car Seat Pad Use and Care

Removing Harness System	51
Removing Seat Pad Set for Cleaning	53
Installing Harness System.....	55

Safety Information

Aircraft Information	59
Replacement and Expiration of Car Seat	60
Child Restraint Use.....	61
Installation in Vehicle.....	61
Vehicle Seating Position	62
Registration and Safety Notices.....	63

Additional Information

Warranty	64
Troubleshooting	64
Replacement Parts List	65
Dorel Juvenile Group Information.....	66

1



Parts of the Car Seat

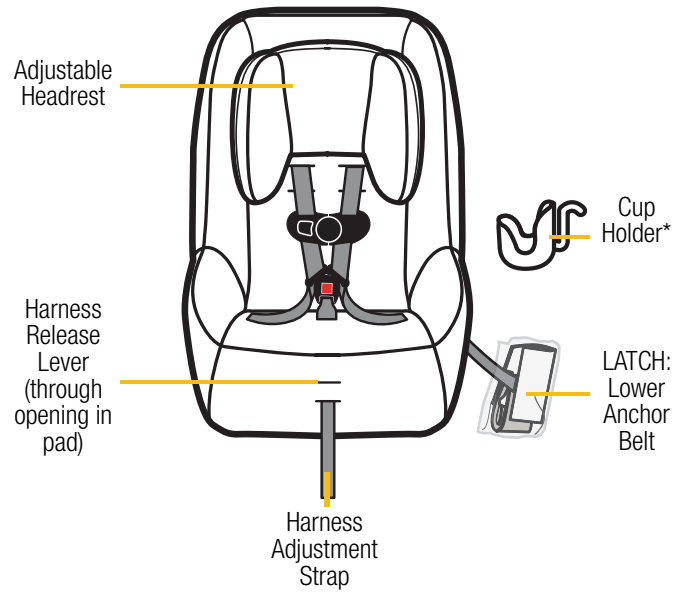

2

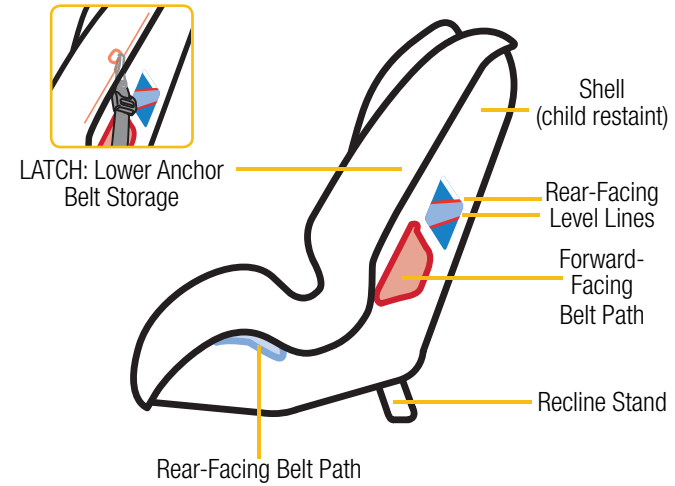

Harness System Detail

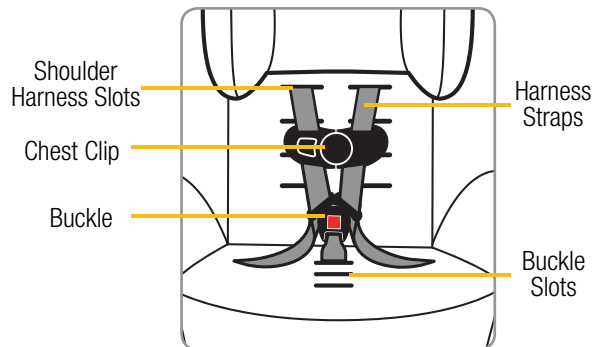

*See page 3 for Accessory Use.

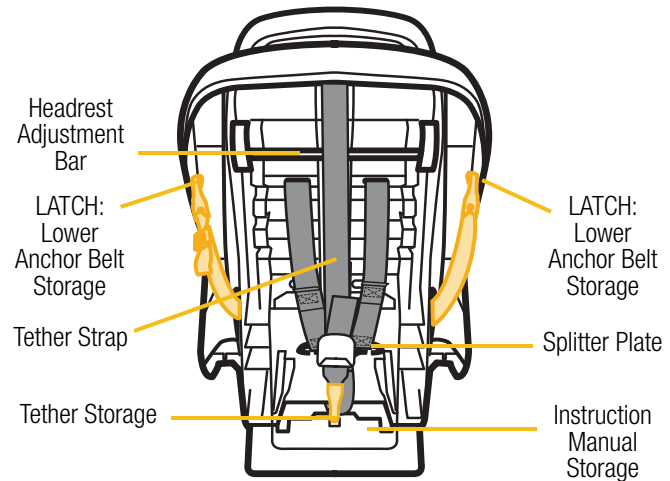

*See page 3 for Accessory Use.



Accessory Use



For Use in Rear-Facing or Forward-Facing Mode

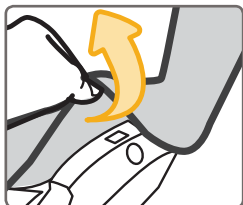

Cup Holder

(on select models)

Pull pad off corner.

Hook bottom of cup holder to edge of shell.

Rotate cup holder up until it snaps into the hole on the shell.

Replace pad.

The cup holder can go on either side of the child restraint.

The removable cupholder is top-rack dishwasher safe.

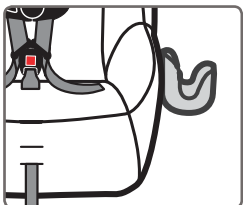
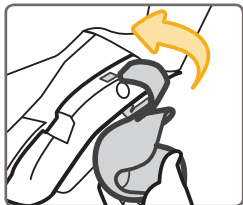

For Use in Rear-Facing Mode Only

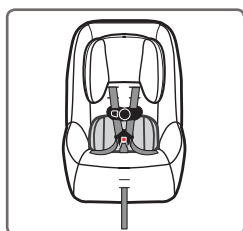

Lumbar Support

(on select models)

The lumbar support provides extra comfort for your child.

To remove the lumbar support, slide out from behind the harness straps.

Choosing Car Seat Mode



Measure your child's weight and height (do not guess) before choosing the car seat's mode.

Your child's height, weight, and age determine how the car seat should be placed in the vehicle.

Children vary widely in body size, shape, and temperament—**please consult your doctor before switching between any of these modes within the limits and fit requirements of the seat.**

State Laws

Please be certain to follow your state's laws regarding car seat use.

American Academy of Pediatrics Recommendations

Infants and Toddlers

Should ride in a rear-facing car seat as long as possible, until they reach the highest weight or height allowed by their seat.

Toddlers and Preschoolers

Once they are facing forward, children should use a forward-facing car seat with a harness for as long as possible, until they reach the height and weight limits for their seats.

School-Aged Children

Once they have outgrown their forward-facing car seat, children should use a belt-positioning booster seat until the vehicle's lap and shoulder seat belt fits properly. This is often when they have reached at least 4 feet 9 inches in height and are 8 to 12 years old.

Older Children

All children younger than 13 years should be restrained in the rear seats of vehicles for optimal protection.

continued on next page



REAR-FACING MODE

5-40 lb (2.3-18 kg) and **19-40 in.** (48-101.6 cm)

Children under 1 year of age must ride **Rear-Facing**.

In this car seat, your child can remain **Rear-Facing** until they outgrow any one of the following:

- **Weight Limit:** 40 lb (18 kg); **OR**
- **Height Limit:** 40 in. (101.6 cm); **OR**
- **Rear-Facing Child Fit** requirements, see page 8



FORWARD-FACING MODE

22-65 lb (10.1-29 kg) and **29-49 in.** (73.6-125 cm)

Children must be at least 1 year of age to ride **Forward-Facing**.

In this car seat, your child can remain harnessed **Forward-Facing** until they outgrow any one of the following:

- **Weight Limit:** 65 lb (29 kg); **OR**
- **Height Limit:** 49 in. (125 cm); **OR**
- **Forward-Facing Child Fit** requirements, see page 9

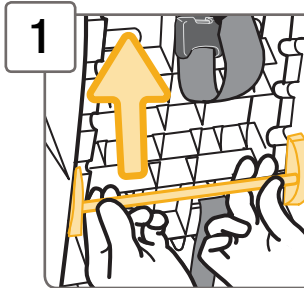

Adjust the Headrest to the Highest Position

Squeeze the headrest adjustment bar on the back of the seat towards you.

Slide the headrest all the way up to expose all of the shoulder harness slots.

Make sure it locks into place.

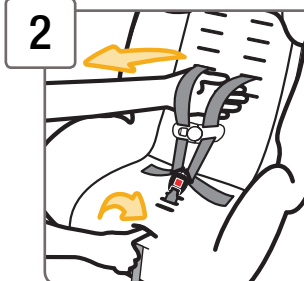
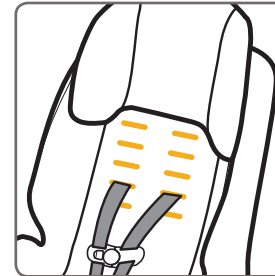

Fully Loosen Harness Straps

Push down on harness release lever (through opening in pad) while pulling out on harness straps as shown.



3

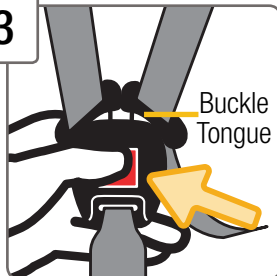

Unbuckle Harness

Press the red button in to release the buckle tongues.

4

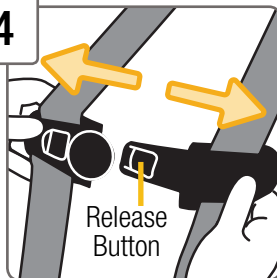

Release Chest Clip

Hold each side of the chest clip and press on the release button with your thumb and pull apart.

5

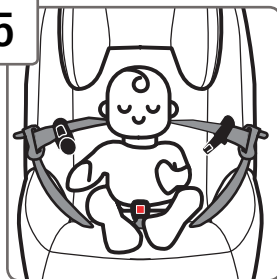

Place Child in Car Seat to Determine Proper Harness Fit

The child's bottom and back should be flat against the car seat.

For **Rear-Facing** child fit, see page 8.

For **Forward-Facing** child fit, see page 9.

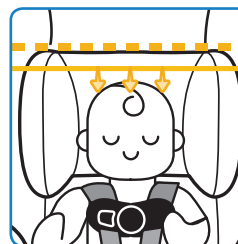

Head Position

The top of your child's head **must be at least 2.5 cm (1 in.) below** the top of the car seat's headrest.

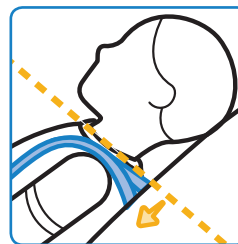

Harness Strap Position

The harness strap **must be at or slightly below** the shoulders; **never above**.

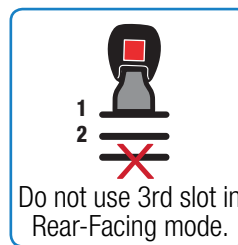

Buckle Position

Buckle must be used in either the **1st or 2nd slot**. Choose the slot closest to your child.

The buckle **should not be underneath or behind** your child.

Need to make adjustments?

To change headrest/harness height, see pages 10-12.

To change buckle position, see pages 13-14.

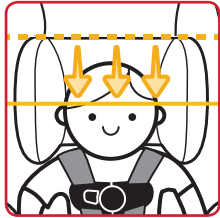

Head Position

The tops of your child's ears **must be below** the top of the car seat's headrest.

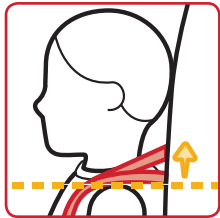

Harness Strap Position

The harness strap **must be at or slightly above** the shoulders; **never below**.

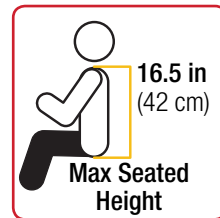

Max Seated Shoulder Height

In this car seat, the maximum seated shoulder height is **16.5 in.** (42 cm).

To measure your child's seated shoulder height: have them sit on the floor with their back flat against a wall. Then measure from the floor up to the top of their shoulder.

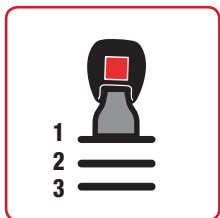

Buckle Position

Buckle can be used in **any slot**. Choose the slot closest to your child.

The buckle **should not be underneath or behind** your child.

Need to make adjustments?

To change headrest/harness height, see pages 10-12.

To change buckle position, see pages 13-14.

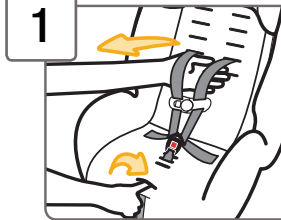

1 Fully Loosen Harness Straps

Push down on harness release lever (through opening in pad) while pulling out on harness straps as shown.

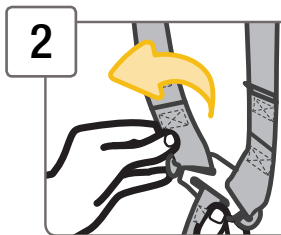

2 From Back of Seat, Remove Harness Strap Loops From Splitter Plate

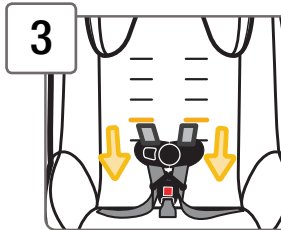

3 Pull Harness Strap Out of Shoulder Harness Slots

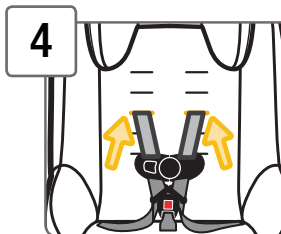

4 Rethread Harness Strap Into Correct Shoulder Harness Slots For Your Child

For **Rear-Facing** child fit, see page 8.

For **Forward-Facing** child fit, see page 9.

continued on next page



5

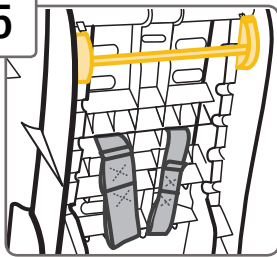

From the Back of Seat, Pull Harness Strap Through Pad and Shell

Harness strap **must** be under the headrest adjustment bar as shown. **Do not** twist harness strap.

6

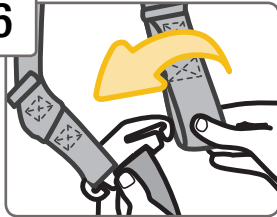

Attach 1st Harness Strap Loops to Splitter Plate As Shown

Sewn ends of the harness strap loops **must** face towards you. **Do not** twist harness strap or harness adjustment strap.

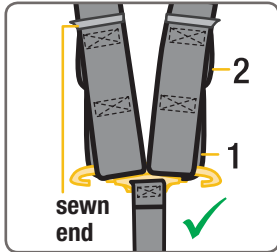

Make sure the same harness strap loops are fitted **completely** on both sides of the splitter plate.

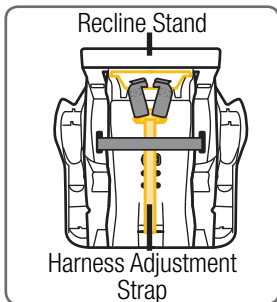

Harness strap loop ends **must** go through the recline stand as shown.

Harness adjustment strap **must** lie under the harness strap as shown.



7

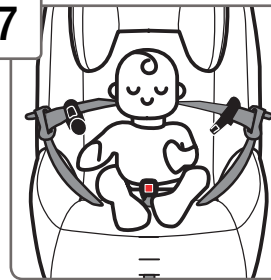

Place Child in Child Restraint to Determine Headrest Position

For **Rear-Facing** child fit, see page 8.

For **Forward-Facing** child fit, see page 9.

8

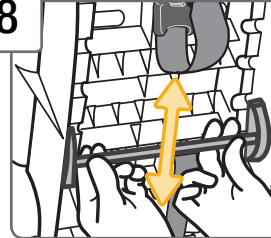

Adjust the Headrest

Squeeze the headrest adjustment bar on the back of the seat towards you.

Raise or lower the headrest to position it behind your child's head.

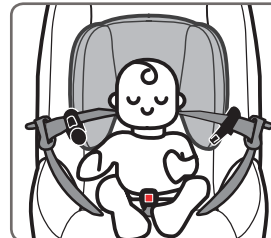

Make sure the metal bar is locked into position and above the harness strap.

Check your child's fit often.

If you cannot achieve a snug harness fit for your child, see pages 15-17.

To learn how to check harness tightness, see pages 48-50.

Check the harness straps often for any wear or damage.

⚠ WARNINGS: The harness system must be installed correctly. Do not use a child restraint with damaged harness straps.

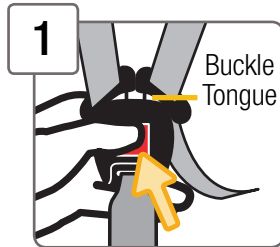
**1 Unbuckle Harness**

Press in on the red button.
Pull buckle tongues out.

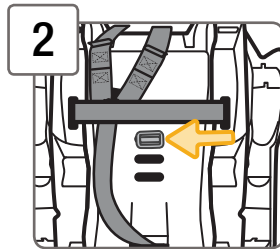

2

Turn Seat Over

Locate buckle's metal retainer on bottom of shell.

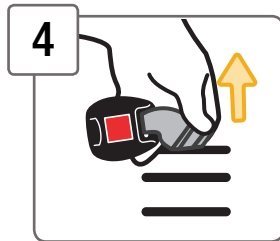

3

Rotate Metal Retainer and Push It Up Through Shell and Pad

4

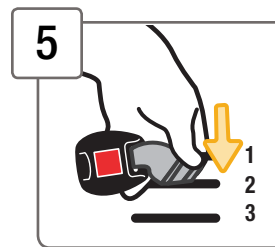
From Top of Seat, Pull Buckle Out of Shell and Pad

5

Insert Buckle's Metal Retainer into Slot Closest to Child

Buckle **must** face out.

Rear-Facing Mode:

You **must** use the 1st or 2nd buckle slots.

Forward-Facing Mode:

Any slot can be used.

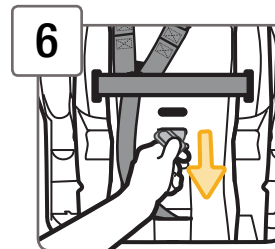

6

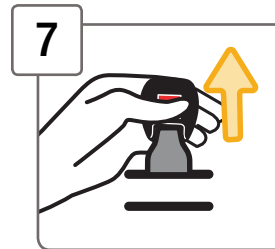
Pull Metal Retainer Completely Through Pad and Shell

7

Check Buckle

Pull up on buckle to make sure it is secured.

The buckle **must not** pull out.

Check your child's fit often.

⚠ WARNING: Failure to place buckle's metal retainer completely through pad and shell can result in serious injury or death.



Harness System Adjustments for Smaller Infants

If you cannot achieve a snug harness fit for your child, you may need to adjust the harness strap and/or buckle strap length as shown in this section.

Adjusting Harness Strap

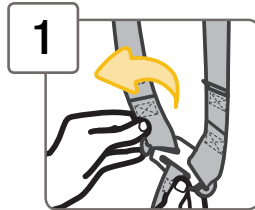

1

From Back of Seat,
Remove Harness Strap Loops
From Splitter Plate

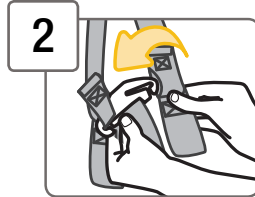

2

Attach 2nd Harness Strap
Loops to Splitter Plate As
Shown

Sewn ends of the harness strap loops
must face towards you.

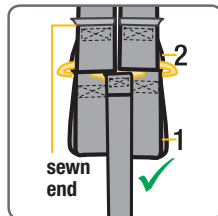
sewn
end

Do not twist harness strap or harness
adjustment strap.

Make sure the same harness strap
loops are fitted **completely on** both
sides of the splitter plate.

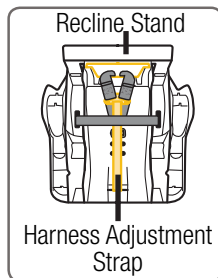

Recline Stand

Harness Adjustment
Strap

Harness strap loop ends **must** go
through the recline stand as shown.

Harness adjustment strap **must** lie
under the harness strap as shown.

Check your child's fit often.

**To learn how to check harness
tightness, see pages 48-50.**



Adjusting Buckle Strap

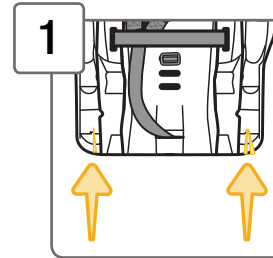

1

Release Elastic Straps
From Tabs on Bottom of
Shell and Pull Seat Pad
Off the Front of the Shell

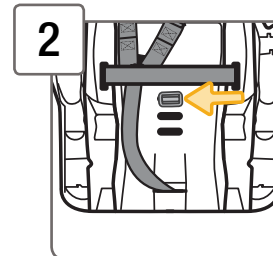
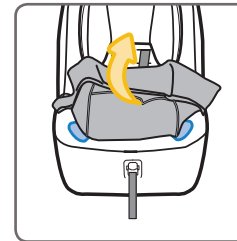

2

With Buckle in the
1st Slot As Shown,
Turn the Seat Over

If you need to move the buckle
to the 1st slot, see pages 13-14.

continued on next page

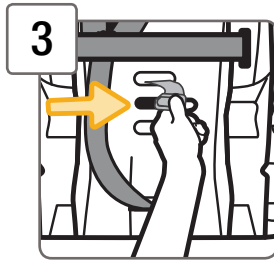

3 From Bottom of Seat, Pull Metal Retainer Towards You and Push It Up into Middle Slot As Shown

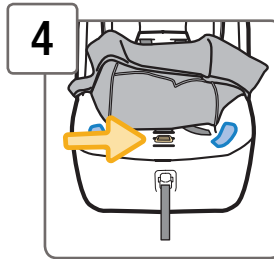

4 From Top of Seat, Lay the Metal Retainer Flat Against the Shell As Shown

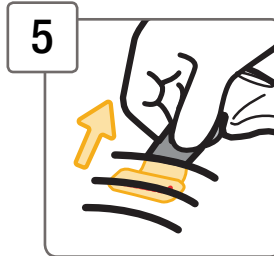

5 Replace Pad and Check Buckle

Pull up on buckle to make sure it is secured.

The buckle **must not** pull out.

Check your child's fit often.

To learn how to check harness tightness, see pages 48-50.

⚠ WARNINGS: The harness system must be installed correctly. Do not use a child restraint with damaged harness straps.



This car seat has 2 positions.

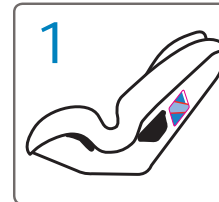

Rear-Facing Mode - 1 Reclined

For children between 5-22 lb (2.3-10 kg), the bottom level line on shell **must** be parallel with the ground.

For children 22-40 lb (10-18 kg) who can sit up unassisted, rotate the child restraint between the 2 level lines.

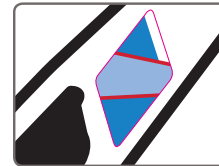

Forward-Facing Mode - 2 Upright

How to Change Positions

Upright

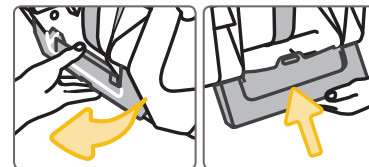

For Upright: Pull recline stand out from under seat and push up to lock in place.

Recline

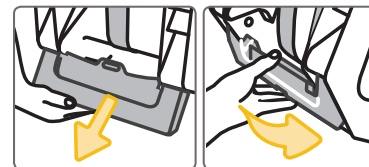

To Recline: Pull down to unlock recline stand and fold under seat.



For Use in Rear-Facing
or Forward-Facing Mode

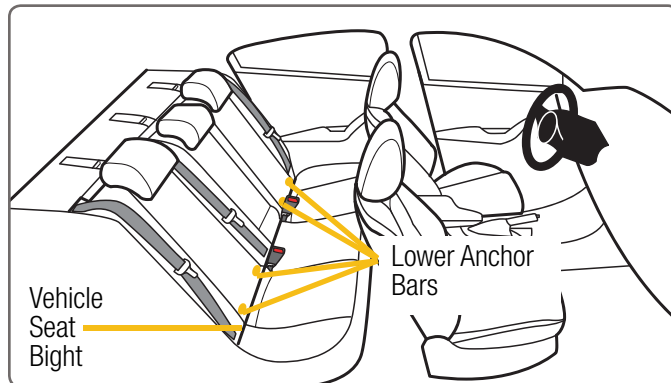

Your vehicle's features may be considerably different than those pictured here.

The lower anchors of LATCH (Lower Anchors and Tethers for Children) is a universal system for installing child restraints without using vehicle seat belts.

The lower anchor can ONLY be used in vehicles that have the lower anchor bars installed in designated seating positions.

Most vehicles manufactured after September 2002 are equipped with lower anchor bars.

Check your vehicle owner's manual to see which seating positions may be equipped with LATCH: lower anchor bars.

WARNINGS

Do not use both the lower anchor belt and vehicle belt at the same time.

When used correctly the lower anchor belt or vehicle belts are equally safe.

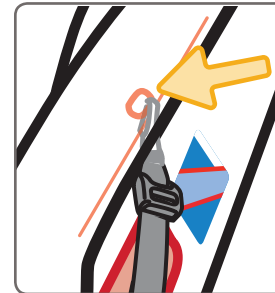

Lower Anchor
Belt Storage Location

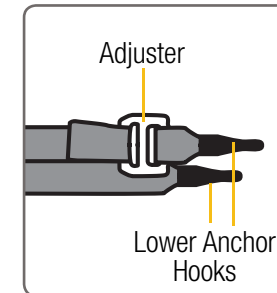

Lower Anchor
Belt Parts

To Remove Lower Anchor Belt from Storage Location on Car Seat: Squeeze spring lever on hooks and remove hooks from storage attachments.

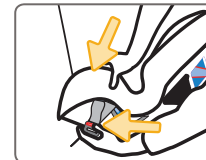

To Remove Lower Anchor Belt from Vehicle Anchor Bars:

Remove tension from the belt by pushing down on side of child restraint with the belt adjuster. Then press the adjuster button to loosen belt.



Unhook from anchor by squeezing spring lever on hook, pushing hook back into the seat bight, and twisting. Then pull it out of the vehicle seat.

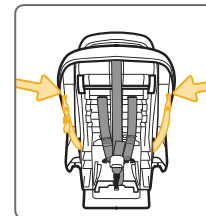

Lower Anchor
Belt Storage
Location

To Store Lower Anchor Belt:

When using vehicle belts or when the car seat is not installed in a vehicle, the lower anchor belt must be properly stored in its storage location.

Thread lower anchor belt through forward-facing belt path. Then attach hooks to attachments behind pad as shown.

Gently tighten to remove slack.

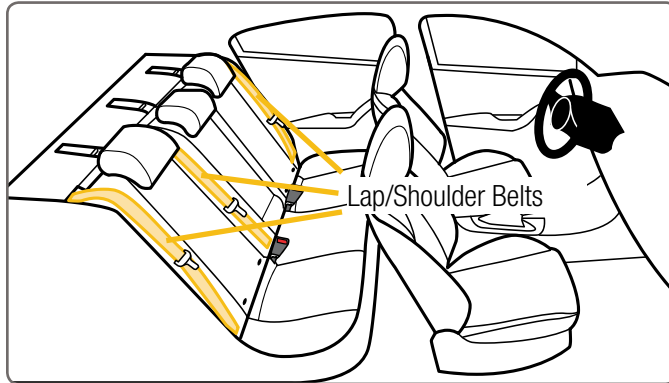

Your vehicle's features may be considerably different than those pictured here.

If lower anchors are not an option or if your child weighs more than 40 lb (18 kg), you must use the vehicle seat belt system to install the child restraint.

Not all vehicle belts and seating positions will work with child restraints.

Please go through the following steps to understand how to lock a child restraint in **Rear-Facing** or **Forward-Facing** mode with a vehicle belt.



1



You MUST Review Your Vehicle Owner's Manual

Your vehicle owner's manual will let you know which vehicle belts and seating positions child restraints can be installed in.

2



Determine How the Child Restraint Will Be Locked Into Place

The vehicle belt **must not** loosen after tightening. This means there needs to be a way to lock the vehicle belt.

The ways this can be done are:

- By using the seat belt's retractor (see step 3); **OR**
- By using the seat belt's latch plate (see step 4).

3

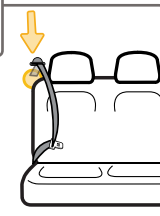

Check the Retractor

Retractors pull seat belts into stored positions and lock the belt to hold passengers in place.

See the next page for some common types of vehicle belt retractors that will work with this child restraint.

continued on next page



Types of Retractors

Switchable Retractor (most vehicles have this type)



This retractor can be switched to a locking mode.

You **must have the retractor in the locking mode** to use the seat belt with this child restraint.

Switching to locking mode: Slowly pull the shoulder belt all the way out, then let it go back in an inch or two.

As it goes back in, you will most likely hear a ratcheting sound.

Gently pull the belt to see if it has locked. You will not be able to pull any more belt out if the lock has engaged.

Automatic Locking Retractor



This retractor always locks.

It will automatically lock after slowly pulling the seat belt out at least halfway and letting the belt go back into the retractor an inch or two.

Emergency Locking Retractor

See Step 4, “Check the Latch Plates”.

If the retractor does not lock, it is most likely an Emergency Locking Retractor. These retractors only lock during a sudden stop or collision.

You will need to determine if your seat belt’s latch plate can lock the belt. See Step 4, “Check the Latch Plates”.



4

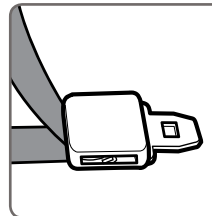
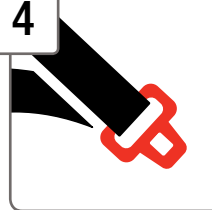

Locking Latch Plate

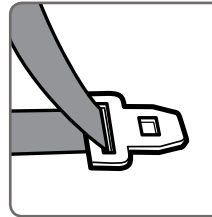

Emergency Locking Retractor with a Sliding Latch Plate

Check the Latch Plates

Latch plates are the part of the seat belt that goes into the buckle.

To see if the latch plate locks:

Buckle the vehicle belt.

Then firmly tug the lap portion of the seat belt while pulling it up.

If the vehicle belt does not slide through the latch plate, it’s locked.

If the latch plate slides up and down the vehicle belt, it is a **sliding latch plate**.

Sliding latch plates easily slip between the lap and shoulder portions of the belt.

If you have an Emergency Locking Retractor with a Sliding Latch Plate, you must use a locking clip.

Please contact us for one. See page 65.

Never Use With This Child Restraint

Emergency Locking Retractor Lap Only Belt



Inflatable Seat Belts





For Forward-Facing Mode Only

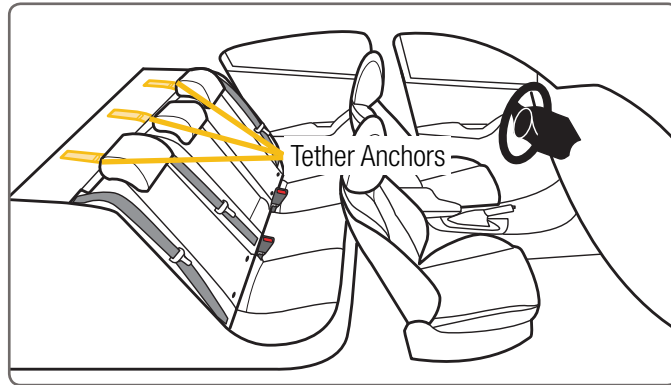

Your vehicle's features may be considerably different than those pictured here.

You **must always attach, adjust, and secure the top anchorage (tether) strap** when installing the child restraint forward-facing with internal harness. Tethers improve the installation and stability of child restraints and reduce the risk of injury.

Attach the tether hook to the tether anchor designated by your vehicle manufacturer for that seating position. Check your vehicle owner's manual for more information.

If the seating position does not have a tether anchor, use a different seating position or see your dealer or a qualified mechanic and have one installed.

WARNINGS

Using this child restraint without the tether strap anchored as recommended by the manufacturer would be a misuse of the child restraint and, in a sudden stop or crash, could result in serious injury or death.

Do not fasten multiple tether hooks on the same tether anchor in the vehicle.



Storing Tether Strap

When installing rear-facing or when the car seat is not installed in a vehicle, attach the tether hook to its storage attachment on back of car seat as shown.

Gently tighten to remove slack.

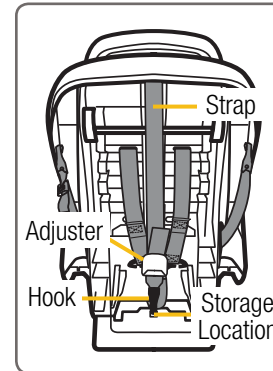

Tether Storage and Parts

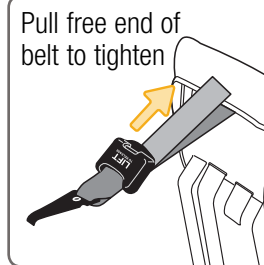

Adjusting Tether Strap

To tighten: After the child restraint is locked into place with the lower anchor belt or vehicle belt, push down on child restraint and gently pull on free end of tether strap.

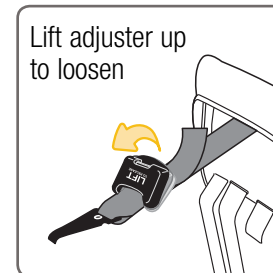

To loosen: Lift up on tether adjuster and push it towards tether hook.



**5-40 lb (2.3-18 kg) and
19-40 in. (48-101.6 cm)**

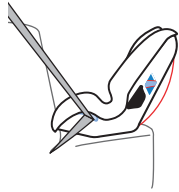

Lap/Shoulder
Belt

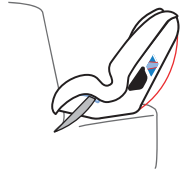

Lap Belt

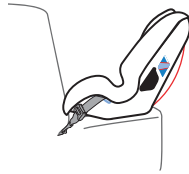

LATCH: Lower
Anchor Belt

⚠️ WARNINGS



Never install a rear-facing child restraint in the front seat of a vehicle equipped with an active frontal airbag.

Do not use the tether for rear-facing mode. Secure tether strap to its storage location.

Do not use the lower anchor belt along with the vehicle lap or lap/shoulder belt.

Check the vehicle belt or the lower anchor belt before each use. Use only if the belt can be tightened properly and locked securely in place.

Do not fasten multiple lower anchor hooks on the same lower anchor bar in the vehicle.

This child restraint **MUST** always face the rear of the vehicle until the child is at least 1 year old and weighs 22 lb (10 kg).

Failure to follow these warnings can result in serious injury or death.



Before you begin installing the seat into your vehicle, did you check:

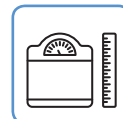

Your child's weight and height?

**5-40 lb (2.3-18 kg) and
19-40 in. (48-101.6 cm)**



Your child's fit? See page 8.

Do you need to make adjustments to the harness/headrest height or the buckle position?

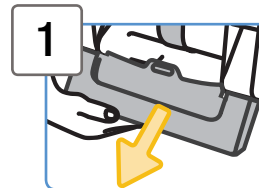

Pull Down Recline Stand to Unlock and Fold It Under Child Restraint

Loosely attach the tether hook to storage location before folding recline stand.

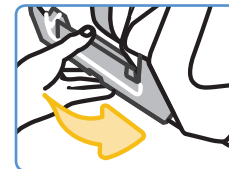

Fold recline stand and then gently tighten tether strap to remove slack.

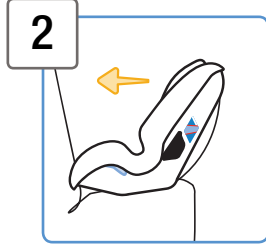

2 Place Car Seat Rear-Facing in Back Seat

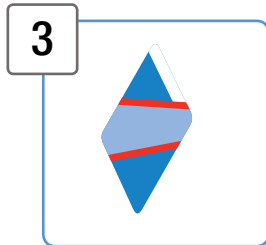

3

Check Rear-Facing Level Lines

For children **between 5-22 lb (2.3-10 kg)**, the bottom level line on shell **must** be parallel with the ground.

For children **22-40 lb (10-18 kg) who can sit up unassisted**, rotate the child restraint between the 2 level lines.

Start by making the bottom level line parallel with the ground, then rotate seat up. **Do not** rotate past the top level line.

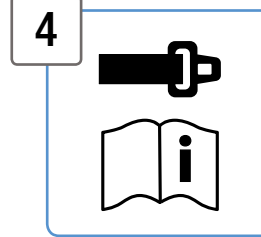
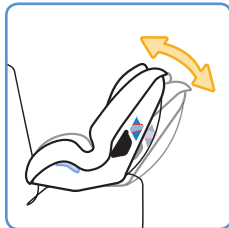

4

Check if Your Vehicle Belts Will Work With This Child Restraint

This is very important because **not all vehicle belts will work with child restraints.**

Review pages 21-24 and your vehicle owner's manual to determine what kind of vehicle belt you have and how to lock a child restraint in place.

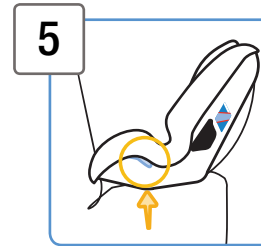

5

Locate Rear-Facing Belt Path

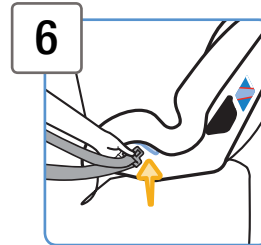

6

Route the Vehicle Belt

Thread the vehicle belt into the **Rear-Facing Belt Path** opening.

Pull it across the seat, under the seat pad, in front of the buckle, and out through the other belt path opening.

Do not twist belt.

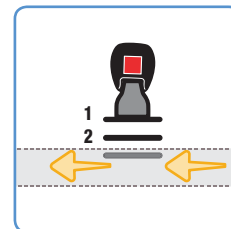

continued on next page



7

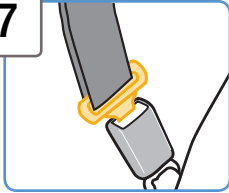

Buckle the Vehicle Belt

8

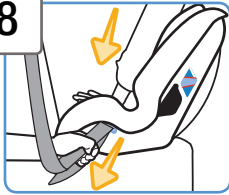

Tighten Belt

Place hand in child restraint.

Firmly push child restraint down and back towards the vehicle seat back while pulling the shoulder belt or the free end of lap belt parallel with the belt path through the belt path opening as shown.

9

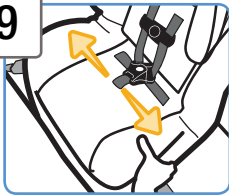

Check Belt Tightness

Hold child restraint at the belt path with your weaker hand. Push and pull from side to side. It should not move more than **1 in. (2.5 cm)**.

If it moves more than 1 in. (2.5 cm), you can try:

- A. Pulling the belt tighter.
- B. Reinstalling the child restraint.
- C. Changing to a different seating location.
- D. Switching to lower anchor belt installation if lower anchors are available in your vehicle.



10

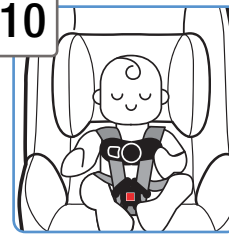

Secure Child in Car Seat

To properly secure your child in the car seat, see pages 48-50.

Check your child's fit often and make any needed adjustments to the car seat as they grow.

11



Recheck Rear-Facing Level Lines

Redo the installation if the child restraint is not reclined according to your child's weight.

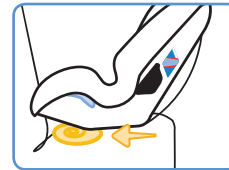

NOTE: You may need to place a tightly rolled towel(s) or foam pool noodle(s) under the front of the child restraint to help achieve the correct recline. Check often to be sure padding is still in place and the belt is tight.



Finished!

Check the tightness of the install often to make sure it has not loosened.



Rear-Facing LATCH: Lower Anchor Install

Before you begin installing the seat into your vehicle, did you check:



Your child's weight and height?

**5-40 lb (2.3-18 kg) and
19-40 in. (48-101.6 cm)**



Your child's fit? See page 8.

Do you need to make adjustments to the harness/headrest height or the buckle position?

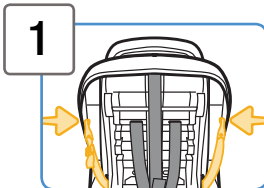

1

Remove Lower Anchor Belt from Storage Location

Or if the lower anchor belt was used Forward-Facing, remove it from the Forward-Facing belt path so both hooks are on the same side of the seat.

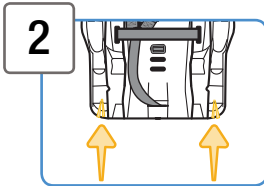

2

Release Elastic Straps From Tabs on Bottom of Shell and Pull Seat Pad Off the Front of the Shell

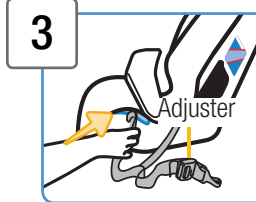
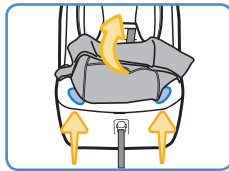

3

Locate Rear-Facing Belt Path

Route the lower anchor hook through the **Rear-Facing Belt Path** opening as shown.

The lower anchor belt adjuster can be on either side of the car seat.

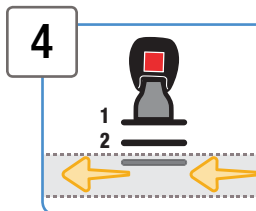

4

Pull Lower Anchor Belt Across the Seat

It must be under the seat pad, in front of the buckle, and go out through the other belt path opening.

Do not twist belt.

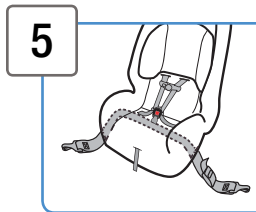

5

Finished Lower Anchor Belt Routing

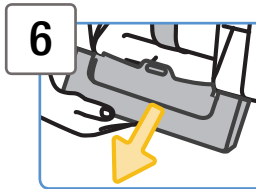

6

Pull Down Recline Stand to Unlock and Fold It Under Child Restraint

Loosely attach the tether hook to storage location before folding recline stand.

Fold recline stand and then gently tighten tether strap to remove slack.

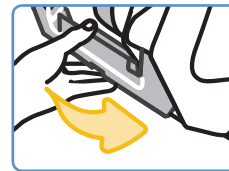

continued on next page

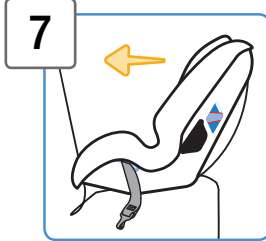

7 Place Car Seat Rear-Facing in Back Seat

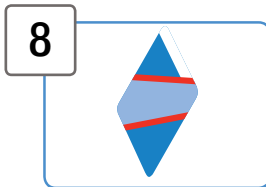

8 Check Rear-Facing Level Lines

For children between 5-22 lb (2.3-10 kg), the bottom level line on shell **must** be parallel with the ground.



For children 22-40 lb (10-18 kg) who can sit up unassisted, rotate the child restraint between the 2 level lines.

Start by making the bottom level line parallel with the ground, then rotate seat up. **Do not** rotate past the top level line.

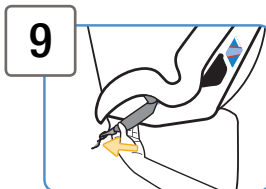

9 Attach Lower Anchor Hooks to Vehicle's Lower Anchors

Review your vehicle owner's manual for lower anchor locations and lower anchor belt use.



Repeat for other side of child restraint.

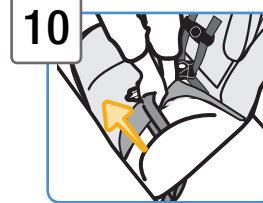

10 Tighten Belt

Place hand in child restraint.

Firmly push child restraint down and towards the vehicle seat back while pulling the free end of the belt parallel with the belt path through the belt path opening as shown.

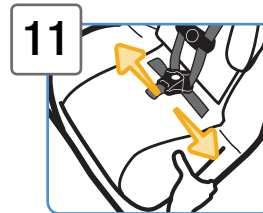
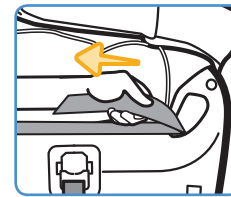

11 Check Belt Tightness

Hold child restraint at the belt path with your weaker hand. Push and pull from side to side.

It should not move more than **1 in.** (2.5 cm).

If it moves more than 1 in. (2.5 cm), you can try:

- A. Pulling the belt tighter.
- B. Reinstalling the child restraint.
- C. Changing to a different seating location.
- D. Switching to vehicle belt installation.

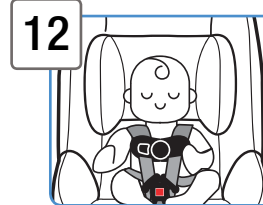

12 Secure Child in Car Seat

To properly secure your child in the car seat, see pages 48-50.

Check your child's fit often and make any needed adjustments to the car seat as they grow.

continued on next page



13



Recheck Rear-Facing Level Lines

Redo the installation if the child restraint is not reclined according to your child's weight.

NOTE: You may need to place a tightly rolled towel(s) or foam pool noodle(s) under the front of the child restraint to help achieve the correct recline. Check often to be sure padding is still in place and the belt is tight.

Finished!

Check the tightness of the install often to make sure it has not loosened.



**22-65 lb (10.1-29 kg)
and 29-49 in. (73.6-125 cm)
and at least 1 year old**

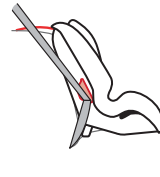

Lap/Shoulder
Belt and Tether



Lap Belt
and Tether

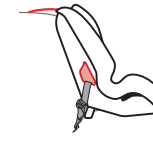

LATCH: Lower Anchor
Belt and Tether

Do not install by this method for a child weighing more than 40 lbs (18 kg).

⚠️ WARNINGS

Do not use the lower anchors of the child restraint anchor-age system (LATCH system) to attach this child restraint when restraining a child weighing more than 40 lbs (18 kg).

The vehicle belt must be used for installation if your child weighs more than 40 lb (18 kg).

Do not use the lower anchor belt along with the vehicle lap or lap/shoulder belt.

Check the vehicle belt or the lower anchor belt before each use. Use only if the belt can be tightened properly and locked securely in place.

Do not fasten multiple lower anchor hooks on the same lower anchor bar in the vehicle.

In this child restraint your child **MUST** be at least 1 year old and weigh 22 lb (10 kg) before they sit forward-facing.

Failure to follow these warnings can result in serious injury or death.



Forward-Facing Vehicle Belt + Tether Install

Before you begin installing the seat into your vehicle, did you check:



Your child's weight and height?

**22-65 lb (10.1-29 kg) and
29-49 in. (73.6-125 cm)**



Your child's fit? See page 9.

Do you need to make adjustments to the harness/headrest height or the buckle position?

1

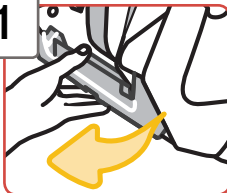

Pull Recline Stand Out From Under Seat and Push Up to Lock in Place

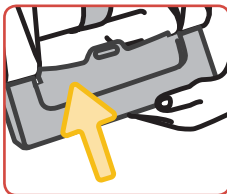

2

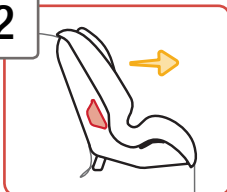

Place Car Seat Forward-Facing in Back Seat

Make car seat flush against vehicle seat. Vehicle seat back must be upright.

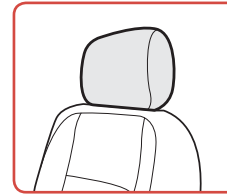

NOTE: If your vehicle seat has a headrest that interferes with achieving a flush car seat fit, check your vehicle owner's manual to see if it can be removed, adjusted, or if there are other possible seating locations.

3

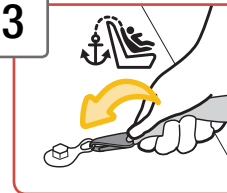

Loosely Attach Tether Hook to Vehicle's Tether Anchor

Check vehicle owner's manual for specific location.

4

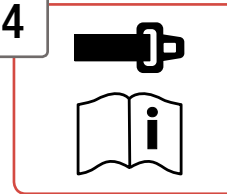

Check if Your Vehicle Belts Will Work With This Child Restraint

This is very important because **not all vehicle belts will work with child restraints.**

Review pages 21-24 and your vehicle owner's manual to determine what kind of vehicle belt you have and how to lock a child restraint in place.

5

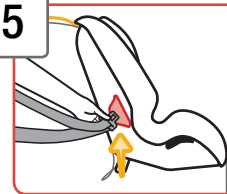

Route the Vehicle Belt

Thread the vehicle belt through **Forward-Facing Belt Path** opening. Pull it across the seat. Then thread it through the other belt path opening.

Do not twist belt.

continued on next page



6

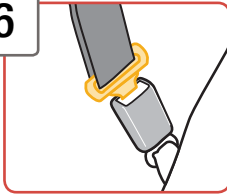

Buckle the Vehicle Belt

7

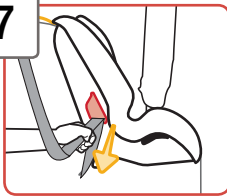

Tighten Belt

Place hand in child restraint.
Firmly push child restraint down while pulling the shoulder belt or free end of the lap belt parallel with the belt path through the belt path opening as shown.

8

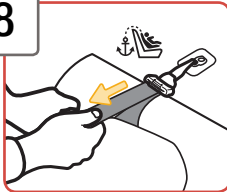

Tighten Tether

Push firmly on the back of the seat and pull the tether strap to remove all slack and create tension on the strap.

9

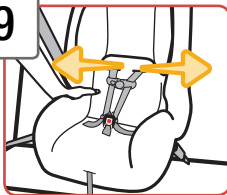

Check Belt Tightness

Hold child restraint at the belt path with your weaker hand.
Push and pull from side to side.
It should not move more than **1 in. (2.5 cm)**.



If it moves more than 1 in. (2.5 cm), you can try:

- A. Putting your knee in the seat and pulling the belt tighter.
- B. Reinstalling the child restraint.
- C. Changing to a different seating location.
- D. Switching to the lower anchor belt installation if lower anchors are available in your vehicle.

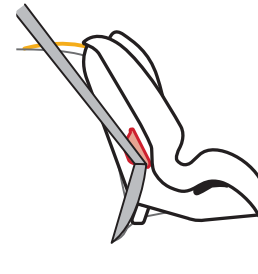

Finished!

Check the tightness of the install often to make sure it has not loosened.



Securing Child in Car Seat

To properly secure your child in the car seat, see pages 48-50.

Check your child's fit often and make any needed adjustments to the car seat as they grow.



Forward-Facing LATCH: Lower Anchor + Tether Install

Do not use the lower anchors of the child restraint anchorage system (LATCH system) to attach this child restraint when restraining a child weighing more than 40 lbs (18 kg).

Before you begin installing the seat into your vehicle, did you check:



Your child's weight and height?

22-40 lb (10.1-18 kg) and
29-49 in. (73.6-125 cm)



Your child's fit? See page 9.

Do you need to make adjustments to the harness/headrest height or the buckle position?

1

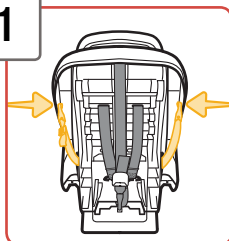

Remove Lower Anchor Belt from Storage Location

Remove it from the rear-facing belt path so both hooks are on the same side of the seat.

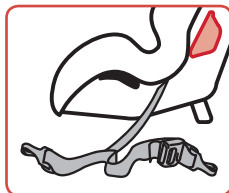

2

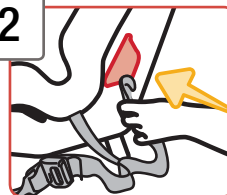

Route the Lower Anchor Hook Through the Forward-Facing Belt Path As Shown

Pull it across the seat. Then thread it through the other belt path opening.

The lower anchor belt adjuster can be on either side of the car seat.

Do not twist belt.

3

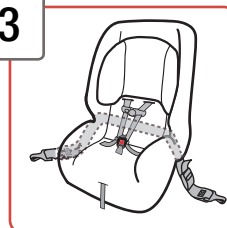

Finished Lower Anchor Belt Routing

4

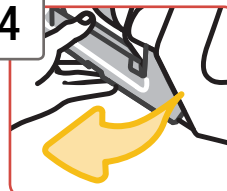

Pull Recline Stand Out From Under Seat and Push Up to Lock in Place

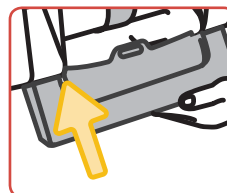

continued on next page

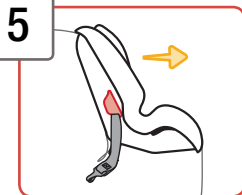

5

Place Car Seat Forward-Facing in Back Seat

Make car seat flush against vehicle seat. Vehicle seat back must be upright.

NOTE: If your vehicle seat has a headrest that interferes with achieving a flush car seat fit, check your vehicle owner's manual to see if it can be removed, adjusted, or if there are other possible seating locations.

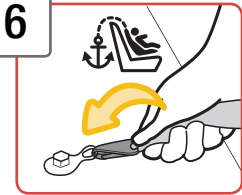
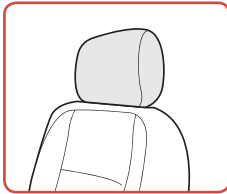

6

Loosely Attach Tether Hook to Vehicle's Tether Anchor

Check vehicle owner's manual for specific location.

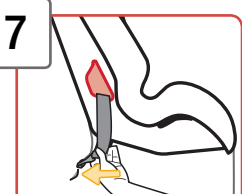

7

Attach Lower Anchor Hooks to Vehicle's Lower Anchors

Review your vehicle owner's manual for lower anchor locations and lower anchor belt use.



Repeat for other side of child restraint.

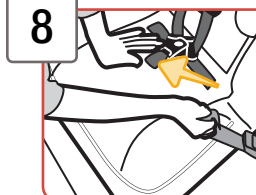

8

Tighten Belt

Place hand in child restraint.

Firmly push child restraint down while pulling the free end of the belt parallel with the belt path through the belt path opening as shown.

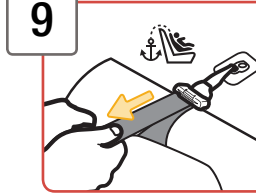
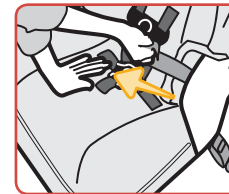

9

Tighten Tether

Push firmly on the back of the seat and pull the tether strap to remove all slack and create tension on the strap.

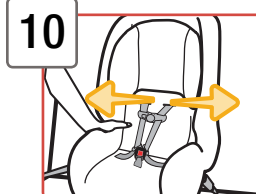

10

Check Belt Tightness

Hold child restraint at the belt path with your weaker hand.

Push and pull from side to side.

It should not move more than **1 in. (2.5 cm)**.

If it moves more than 1 in. (2.5 cm), you can try: A. Putting your knee in the seat and pulling the belt tighter. B. Reinstalling the child restraint. C. Changing to a different seating location. D. Switching to vehicle belt installation.

continued on next page

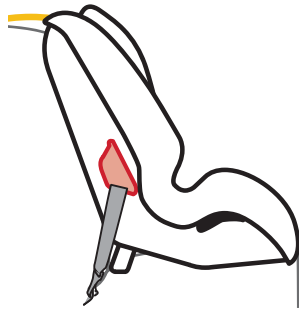

Finished!

Check the tightness of the install often to make sure it has not loosened.



Securing Child in Car Seat

To properly secure your child in the car seat, see pages 48-50.

Check your child's fit often and make any needed adjustments to the car seat as they grow.



1

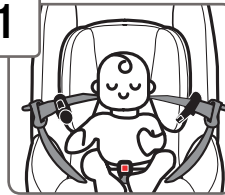

Place Child in Car Seat

The child's bottom and back should be flat against the car seat.

Position harness straps over your child's shoulders and upper thighs.

2

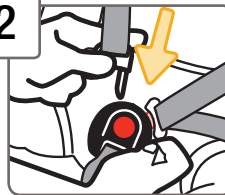

Buckle Harness

Push buckle tongues into buckle until you hear them "click".

Pull up on harness straps to make sure buckle is locked.

3

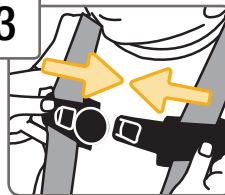

Fasten Chest Clip

Insert right half of chest clip into left half and snap together.

continued on next page

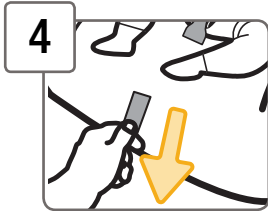

4

Tighten Harness

Pull on harness adjustment strap to snugly tighten harness.

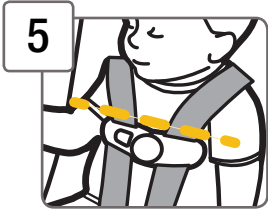

5

Position Chest Clip

Slide chest clip up the harness straps and position it at mid-chest (even with armpits) and away from the child's neck.

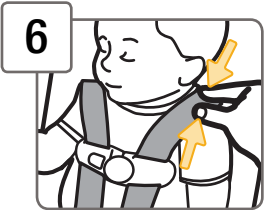

6

Check Harness Tightness

Try to pinch the harness at the shoulders vertically between index finger and thumb as shown.

If your fingers slip off, the harness is tight enough.

If you can pinch the harness strap, tighten more.

A snug strap should not allow any slack. It lies in a relatively straight line without sagging. It does not press on the child's flesh or push the child's body into an unnatural position.

If you cannot achieve a snug harness fit for your child, you may need to adjust the harness system. See pages 15-17.

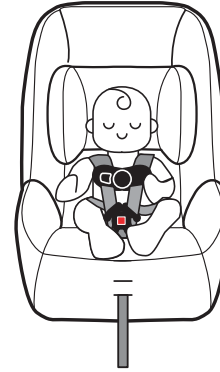

Finished!

The child is now secured in the car seat.
Check your child's fit often and make any needed adjustments to the car seat as they grow.

To Remove Child from Car Seat:

1. Loosen Harness Strap
2. Unbuckle Harness
3. Release Chest Clip
4. Remove Child

⚠️ WARNINGS

Failure to fasten and tighten the harness system correctly may allow the child to be ejected from the child restraint in a crash or sudden stop causing serious injury or death.



Do not mistake comfort for safety. Harness system must be snugly adjusted.

Do not put snowsuits or bulky garments on your child when placing them in the child restraint. Bulky clothing can prevent the harness straps from being tightened properly.

Only remove the harness system to clean the seat pad.

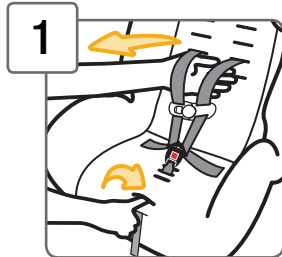

1 Fully Loosen Harness Straps

Push down on harness release lever (through opening in pad) while pulling out on harness straps as shown.

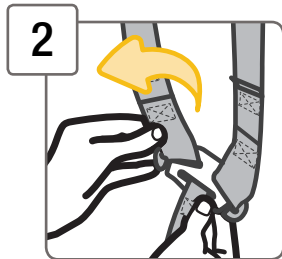

2 From Back of Seat, Remove Harness Strap Loops From Splitter Plate

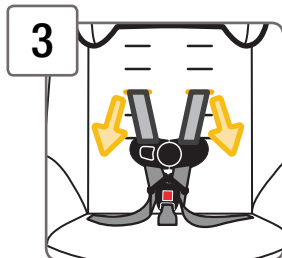

3 Pull Harness Strap Out of Shoulder Harness Slots

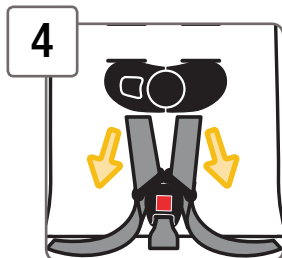

4 Unthread Chest Clip

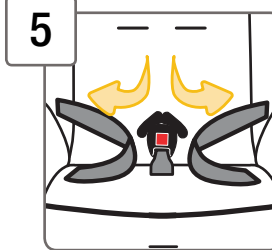

5 Unthread Buckle

Do not unbuckle.

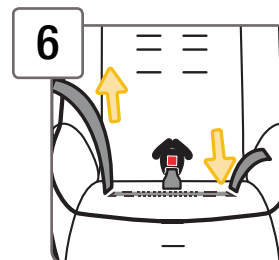

6 Pull Harness Strap Out of Seat

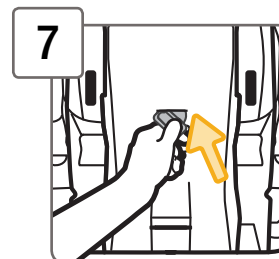

7 Turn Seat Over

Locate buckle's metal retainer on bottom of shell.

Rotate metal retainer and push it up through shell and pad.

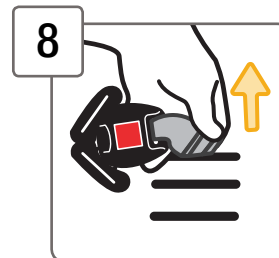

8 From Top of Seat, Pull Buckle Out of Shell and Pad

Removing Seat Pad Set for Cleaning

You need to remove the harness system and accessories to remove the pad from the shell. To remove accessories, see page 3. To remove harness system, see pages 51-52.

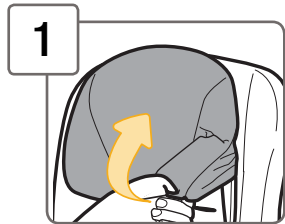

1 Pull Headrest Pad Off Bottom of Headrest As Shown

Remove headrest pad from shell.

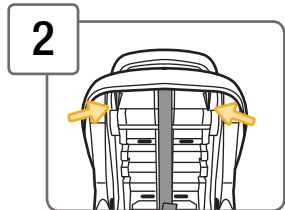

2 Release Elastic Straps from Tabs on Back and Bottom of Shell As Shown

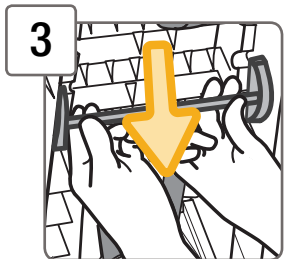
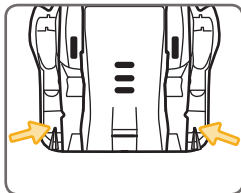

3 Adjust the Headrest to the Lowest Position

Squeeze the headrest adjustment bar on the back of the seat towards you. Slide the headrest all the way down. Make sure it locks into place.

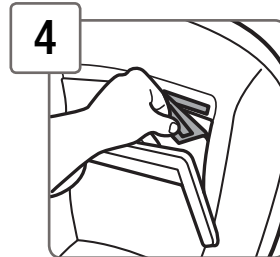

4 Undo Fastening Strip Behind Headrest

(on select models)

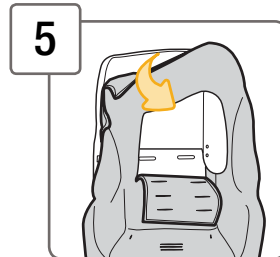

5 Remove Pad

Pull pad off the top of child restraint, around the headrest, and remove pad.

⚠ WARNINGS: Do not use child restraint without the seat pad or with damaged harness straps.

Cleaning Pad and Accessories

Machine wash separately with cold water on a gentle cycle. Do not use bleach. Tumble dry separately for 10-12 minutes on low heat. Remove immediately.

Cleaning Harness Straps

Check the harness straps often for any wear or damage.

Spot clean using warm sudsy water and damp cloth.

Spilled food and liquids on the car seat may result in mold or bacterial growth over time. These spills could also attract insects or rodents.

Replace Pad

Adjust the headrest to the highest position. Starting from the bottom, gently pull headrest pad onto headrest.

Starting from bottom of child restraint, slip pad on shell. Pull harness adjustment strap through pad. Wrap pad around the top of shell. Attach fastening strip (on select models). Attach elastic straps. Install harness system, see pages 54-58.

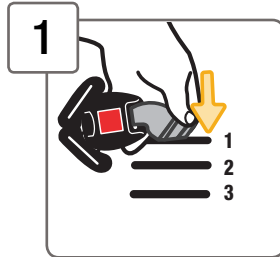

1 Insert Buckle's Metal Retainer into Slot Closest to Child

Buckle **must** face out.

Rear-Facing Mode:

You **must** use the 1st or 2nd buckle slots.

Forward-Facing Mode:

Any slot can be used.

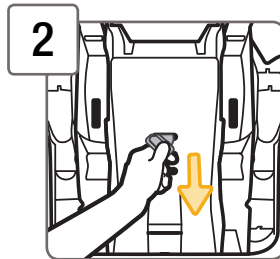

2 Pull Metal Retainer Completely Through Pad and Shell



3 Check Buckle

Pull up on buckle to make sure it is secured.

The buckle **must not** pull out.

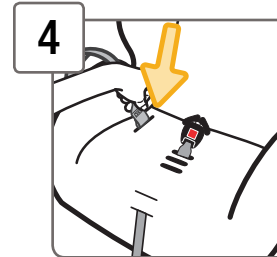

4 Thread Harness Strap

With sewn end of harness strap loop facing the buckle, thread harness strap down through hip harness slot.

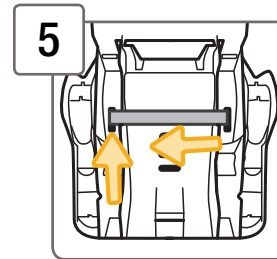

5 Pull Harness Strap Across Bottom of Shell

Push harness strap up through other hip harness slot.

Do not twist harness strap.

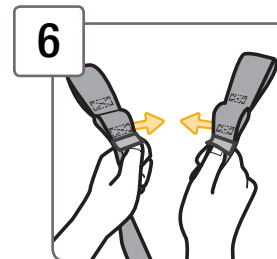

6 Make Harness Strap Even

Sewn ends of harness strap loops **must** face each other when you hold them up.

continued on next page

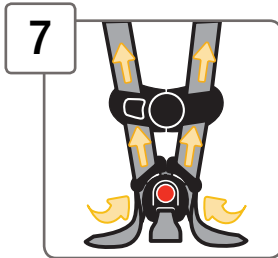

7 Thread Buckle and Chest Clip

Harness strap ends go through the **back** of buckle tongues and through the chest clip **front to back** as shown.

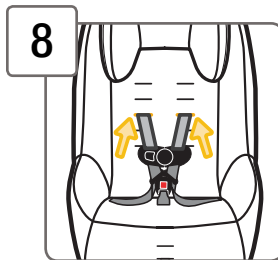

8 Thread Harness Straps into Correct Shoulder Harness Slots for Your Child

Harness strap **must** be under the headrest adjustment bar as shown.

Do not twist harness strap.

For **Rear-Facing** child fit, see page 8.

For **Forward-Facing** child fit, see page 9.

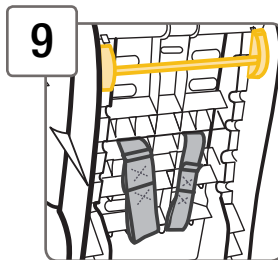

9 From the Back, Pull Harness Strap Through Pad and Shell

Harness strap **must** be under the headrest adjustment bar as shown.

Do not twist harness strap.

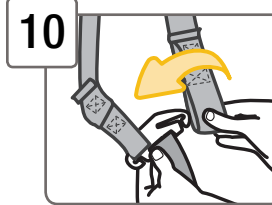

10 Attach 1st Harness Strap Loops to Splitter Plate As Shown

Sewn ends of the harness strap loops **must** face towards you. **Do not** twist harness strap or harness adjustment strap.

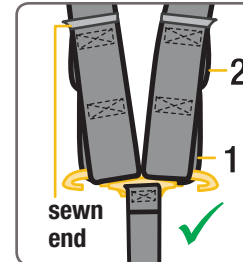

Make sure the same harness strap loops are fitted **completely** on both sides of the splitter plate.

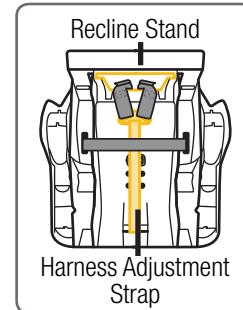

Harness strap loop ends **must** go through the recline stand as shown.

Harness adjustment strap **must** lie under the harness strap as shown.

Check your child's fit often.

If you cannot achieve a snug harness fit for your child, see pages 15-17.

To learn how to check harness tightness, see pages 48-50.

Check the harness straps often for any wear or damage.

⚠ WARNINGS: The harness system must be installed correctly. Do not use a child restraint with damaged harness straps.



This restraint is certified for aircraft use when used with the internal harness.

Install the child restraint in a window seat to avoid blocking the aisle. If the aircraft lap belt is too short, ask the flight attendant for a belt extender.

Use only on forward-facing aircraft seats.



Contact the airline for their specific policies.

Some airlines may ask to see a label stating that this child restraint is certified for aircraft use.

There is an airplane certification label located on the side of this child restraint as shown.

⚠ WARNING: Store lower anchor belt and tether strap when installing with aircraft belts.



Rear-Facing Aircraft Installation

Follow the steps on pages 28-32.



Forward-Facing Aircraft Installation

Follow the steps on pages 39-42, skipping the tether strap steps.



Do not risk your child's safety.

To keep your child as safe as possible, Dorel Juvenile Group strongly recommends replacing the car seat even after a minor crash; even if it was not occupied at the time.

Replacement After a Minor Crash

The National Highway Traffic Safety Administration states that for a crash to be considered minor **ALL of the following must be true:**

- Vehicle able to drive away from the crash site; **AND**
- Vehicle door nearest the car seat was not damaged; **AND**
- No passengers were injured; **AND**
- Airbags did not deploy; **AND**
- There is no visible damage to the car seat.

If the crash your car seat was involved in meets **ALL** the criteria, you may not need to replace the car seat.

If one or more of these criteria are not true or if you are uncertain of any of your answers, replace the car seat immediately.

Replacement After a Moderate to Severe Crash

You **must** replace this car seat if it has been in a moderate to severe car crash.

This car seat is intended to protect a child in a single crash. During a crash, the car seat and all of its parts absorb crash energy which can deform or weaken it. Damage is not always visible. A damaged car seat must be replaced immediately.

Expiration



On the side of the child restraint there is a date of manufacture label as shown.

Do not use this child restraint more than 10 years after the date of manufacture.



Child Restraint Use

Never take your child out of the child restraint while the vehicle is moving.

Never leave child unattended. Placing your child in a hot child restraint may result in burns.

Do not use a child restraint with damaged or missing parts.

Do not use a child restraint with cut, frayed or damaged harnesses.

Do not substitute parts or try to modify the child restraint in any way. Do not lubricate buckles and fasteners.

Do not use any child restraint accessory except those approved by Dorel Juvenile Group.

Never allow any child to play with this child restraint; it is not a toy.

Do not remove or cover up any of the warning labels or other labels on the child restraint.

This child restraint has been certified for use in passenger vehicles. Do not use in a boat, on a motorcycle or in a cargo van or bus where there are no seat belts or tether anchors.

Read all instructions for additional warnings.

Installation in Vehicle

Check the vehicle belt or lower anchor belt before each use. Use only if the belt is tightened properly and locked securely in place.

This child restraint should be securely belted in the vehicle even when not in use. In a crash or sudden stop, an unsecured child restraint could injure occupants.



Vehicle Seating Position



Never place a child rear-facing in a seating position with an active frontal air bag.

Check the vehicle owner's manual for more information about air bag/child restraint use.



Use the child restraint only on vehicle seats that face forward.



Do not use on seats that face the sides or rear of the vehicle.

For vehicles without a back seat, refer to your vehicle owner's manual.



Children are safer when properly restrained in rear seating positions than in the front seating positions.

According to accident statistics, children in rear seating positions are statistically safer, whether you have air bags, advanced air bags, or no air bags at all.

If you are not sure where to place the child restraint in your vehicle: consult your vehicle owner's manual or contact Dorel Juvenile Group Consumer Care Department.

To avoid your child being seriously burned, take the following precautions:

1. Park in the shade or where sun does not directly hit the child restraint.
2. Cover the child restraint with a sheet or blanket when not in use.
3. Check for hot seat and buckles before placing child in child restraint.

To help protect your vehicle seat's upholstery from damage, use a single layer towel underneath and behind child restraint.



Please complete the postage-paid registration card that came with your child restraint, and send it to us. Child restraints could be recalled for safety reasons. You must register this restraint to be reached in a recall. Send your name, address, e-mail address if available and the restraint's model number and manufacturing date to:

**Dorel Juvenile Group, Inc.
Consumer Care Department**

PO Box 2609, Columbus, IN 47202-2609

or call 1-800-544-1108 or register online at www.djgusa.com/registration/carseat/us.

For recall information, call the U.S. Government's Vehicle Safety Hotline at 1-888-327-4236 (TTY: 1-800-424-9153), or go to <http://www.NHTSA.gov>.

Consumer: Just fill in your name, address and email. Please print (use dark ink).

Your Name _____

Your Street Address _____

City _____ State _____ Zip Code _____

Email Address (optional) _____

Model Number: AB123CDE

Model Name: COSCO CARSEAT

Manufacture Date: 05/16/2018

#11 B26503F



Example of model number, line code and manufacture date.

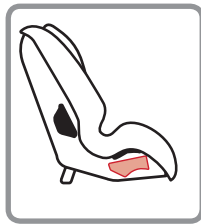

If you don't have the card or if your address changes, you will find the model number, manufacture date, and line code on the label located on side of shell.

Dorel Juvenile Group, Inc. (DJG) warrants this product to the original retail purchaser as follows: This product is warranted against defective materials or workmanship for one year from the date of original purchase. **An original receipt is required to validate your warranty.** DJG will, at its option, provide replacement parts or replace this product. DJG reserves the right to substitute if the part or model has been discontinued.

To make a claim under this warranty, please contact our Consumer Care Department by phone: 1-800-544-1108; text: 1-812-652-2525; or chat with us: www.coscokids.com.

Proof of purchase is required and shipping charges are the responsibility of the consumer.

Warranty Limitations: This warranty does not include damages which arise from misuse or abuse of this product.

Limitation of Damages: The warranty and remedies as set forth are exclusive and in lieu of all others, oral or written, expressed or implied. In no event will DJG or the dealer selling this product be liable to you for any damages, including incidental or consequential damages, arising out of the use or inability to use this product.

Limitation of warranties and other warranty terms and state law rights: Any implied warranties, including implied warranties of the merchantability and fitness for a particular purpose, shall be limited to the duration and terms of the express written warranty. Some states do not allow limitations as to how long an implied warranty lasts or the exclusion or limitation of incidental or consequential damages, so the above limitations may not apply to you.

This warranty gives you specific legal rights, and you may have other rights, which vary from state to state. Neither DJG nor the dealer selling this product authorized any person to create for it any other warranty, obligation, or liability in connection with this product.

Troubleshooting

- 1. If the child restraint buckle or harness release lever sticks or you cannot get the straps tight enough around child: DO NOT LUBRICATE.** Check around lever and retractor for dropped food, sticky spilled drinks, dirt, leaves, etc. Clean with warm water and/or remove object with tweezers. If you cannot get the harness to adjust and remain tight with the buckle securely locked, do not use the child restraint.
- 2. If your harness twists:** Straighten the harness each time you put your child in the child restraint to help prevent twisting. Lock the buckle and tighten harness so it will be ready for next use.

If requested color is not available, similar color will be substituted. Prices are subject to change. Applicable tax and shipping & handling will also be added.

Part	Cost
Buckle Assembly	\$7.99
Seat Pad Set.....	\$30.00
Cup Holder (1)	\$2.50
Chest Clip.....	\$1.50
Tether	\$6.00
Lower Anchor Belt.....	\$17.99
Instructions.....	\$0.00
Locking Clip.....	\$2.50

For parts availability and questions:

Call: 1-800-544-1108

Text: 1-812-652-2525

Chat: www.coscokids.com

Hours of Operation:

M-TH from 8:00 AM to 6:00 PM EST

FRI from 8:00 AM to 4:30 PM EST

If you already know which parts you need,
you may complete your order with a credit card
by calling us at 1-800-544-1108.

See list above for available parts.

We accept Visa or MasterCard.

Thank you for choosing this child restraint. The DJG family is committed to creating child restraints with the most comfort and convenience available today.

Remember, parents are a child's first teachers and examples. If you always buckle your seat belt, your child will think it is the natural thing to do. Make it a firm rule that the vehicle does not go until everyone is buckled up. Make no exceptions.

No one can predict if use of a child restraint will prevent injury or death in a particular crash.

However, when combined with careful driving, proper use of a child restraint can lower a child's risk of injury or death in most crashes.

If you still have questions or have any concerns with this child restraint, please contact our Consumer Care Department:

Call: 1-800-544-1108

Text: 1-812-652-2525

Chat: www.coscokids.com

Hours of Operation:

M-TH from 8:00 AM to 6:00 PM EST

FRI from 8:00 AM to 4:30 PM EST